

Quick Manual

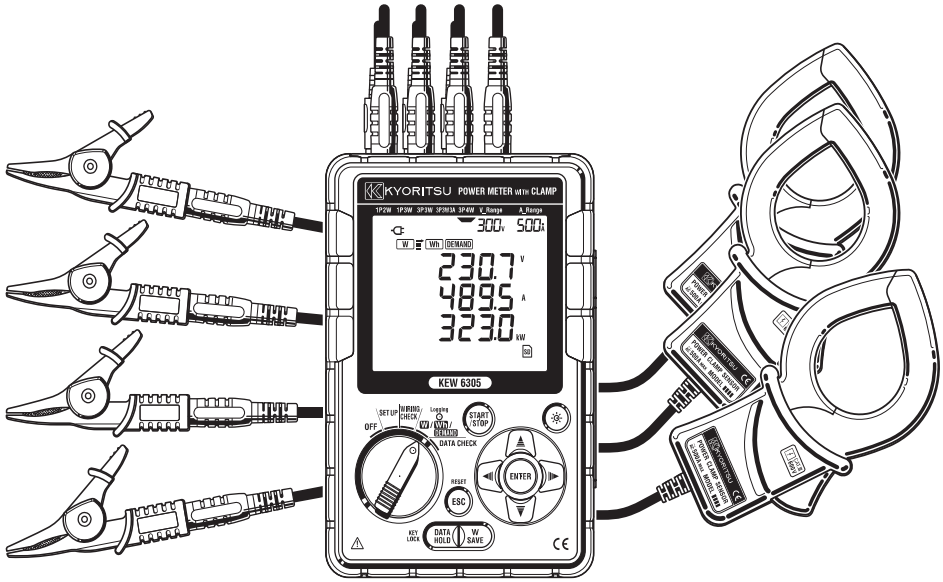

DIGITAL POWER METER

KEW 6305



**KYORITSU ELECTRICAL
INSTRUMENTS WORKS, LTD.**

● Preface

This Quick manual is a simplified version of the full instruction manual which can be found in the supplied CD-ROM. **This manual is intended only as a handy reference guide and should only be used after having read the full instruction manual which contains full details on each function of this instrument and the items contained in the package.**

● Precautions

The instruction manual (full manual) contains warnings and safety procedures which have to be observed to ensure safe operation of the instrument and maintain it in a safe condition. Thus, these operating instructions have to be read prior to using the instrument.

Contents

1. Instrument Overview.....	2
2. Instrument Layout.....	4
3. Preparations.....	7
4. Set-up: SET UP Range.....	9
5. Measurement Ranges.....	13
6. Instantaneous value Measurement: W Range.....	14
7. Integration value Measurement: Wh Range.....	18
8. Demand Measurement: DEMAND Range.....	21
9. SD card/ Saved data.....	24
10. Wiring check: WIRING CHECK Range.....	27
11. Data check: DATA CHECK Range.....	29

The latest software can be downloaded from our web site.

www.kew-ltd.co.jp

1. Instrument Overview

Features

This is a digital Power meter that can be used for various wiring systems and can measure up to 3 systems on single-phase 2-wire circuit. That is, this instrument does the jobs of three just by one. It can be used for measurements of instantaneous, integration and also demand values.

Measured data can be saved in SD card or the internal memory, and the data can be transmitted to PC via USB. Measured data can be checked on android devices in real-time by using Bluetooth function.

Safety construction

Designed to meet the international safety standard IEC 61010-1 CAT III 600V

Wiring configuration

KEW6305 supports: Single-phase 2-wire, Single-phase 3-wire, Three-phase 3-wire and Three-phase 4-wire

Measurement and calculation

KEW6305 measures voltage (RMS), current (RMS), active power, frequency and calculates reactive/apparent power, power factor, neutral current (Three-phase 4-wire only) and active/ reactive/apparent energy.

Demand measurement

Electricity consumption can be easily monitored so as not to exceed the target maximum demand values.

Saving data

Instantaneous values can be saved every time pressing the  Key. Integration and demand values can be saved for various periods from 1 second up to 1 hour. The maximum, minimum and average values of instantaneous values during each cycle can also be saved.

Dual power supply system

KEW6305 operates either with an AC power supply or with batteries. In the event of interruption, while operating with an AC power supply, power to the instrument is automatically restored by the batteries in the instrument.

Large display

Up to 3 measured items can be displayed on the large screen simultaneously.
(e.g. voltage, current and active power)

Backlight

Backlight to facilitate working in dimly illuminated areas

Light & compact design

Clamp sensor type, compact and light weight design

Application

Data in the internal memory and in SD card can be transferred to PC using USB connection or SD slot. The supplied PC software application enables easy settings of the instrument and analysis of the saved data from PC, moreover, can synchronize recording intervals and internal clocks of two KEW6305 to perform synchronous measurement. Measured data can be checked on android devices in real-time via Bluetooth communication.

Functional Overview

SET UP

Configures KEW6305 and makes settings for measurements.

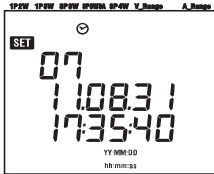

WIRING CHECK

Performs a check for proper connection.



See (Section 10) "Wiring check" for further details.

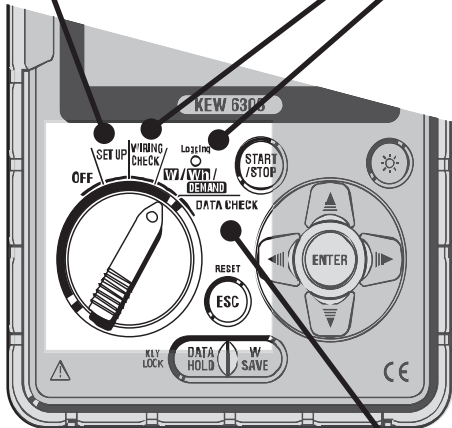

[W] Instantaneous value measurement

Measures average, max, min values of instantaneous values of current, voltage and electric power.

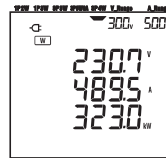

See (Section 6) "Instantaneous value measurement" for further details.

[Wh] Integration value measurement

Measures active/apparent/reactive powers on each CH.

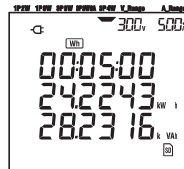

See (Section 7) "Integration value measurement" for further details.

DATA CHECK

Displays the saved data on the LCD.

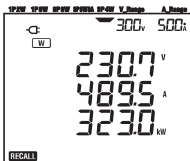

See (Section 11) "Data Check" for further details.

[DEMAND] Demand value measurement

Measures demand values based on the preset target values.

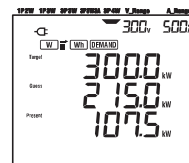

See (Section 8) "Demand measurement" for further details.

2. Instrument Layout

Front view

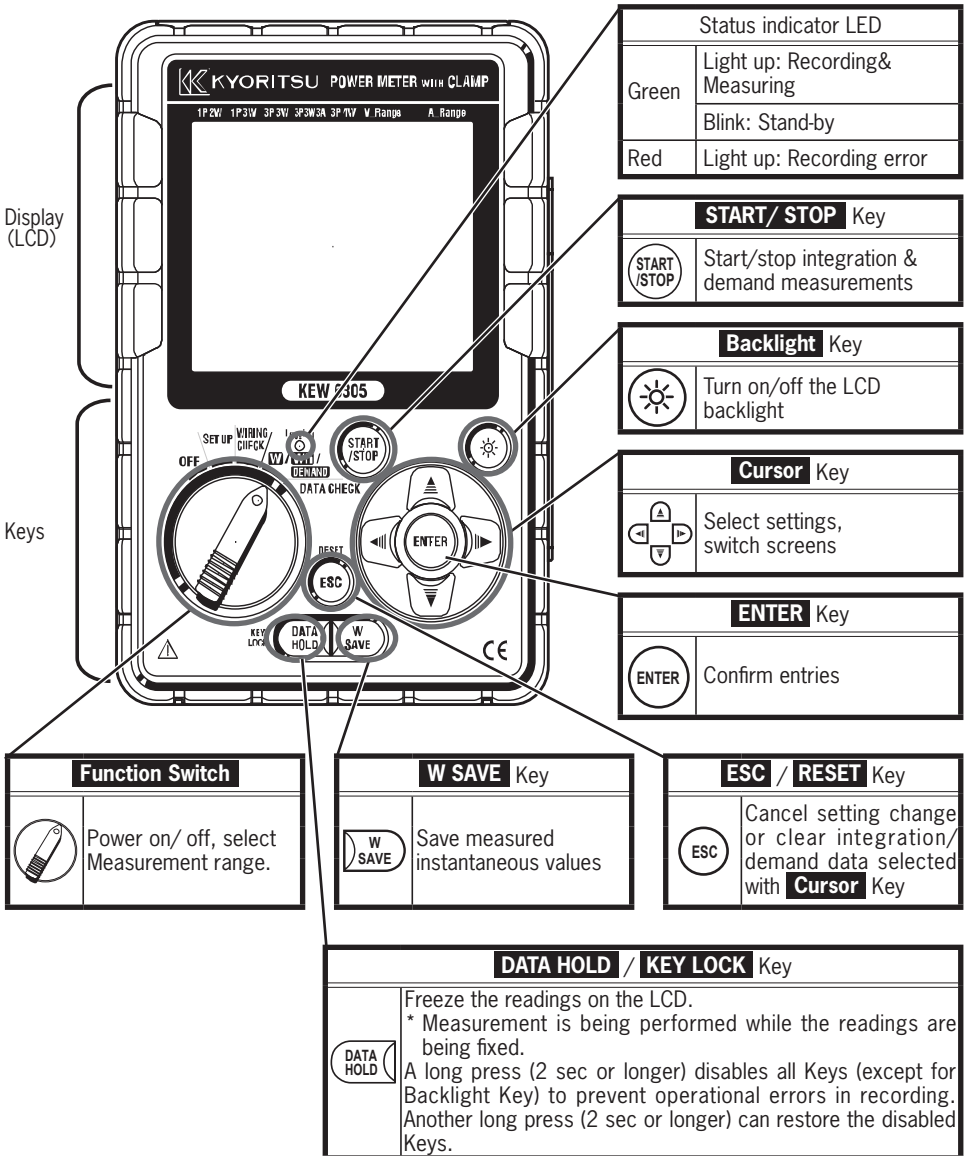

Connector

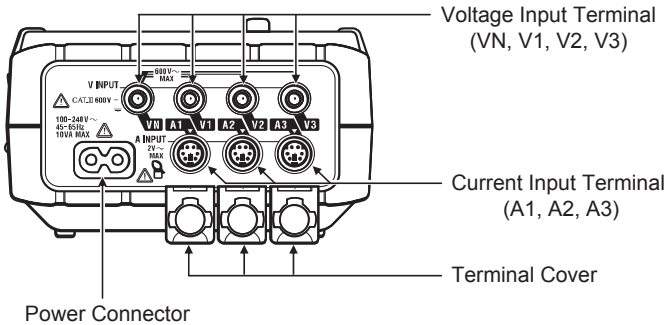

Side face

< When the Connector Cover is closed >

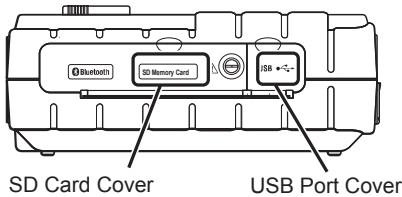

< When the Connector Cover is opened >

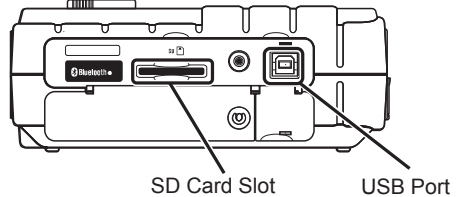





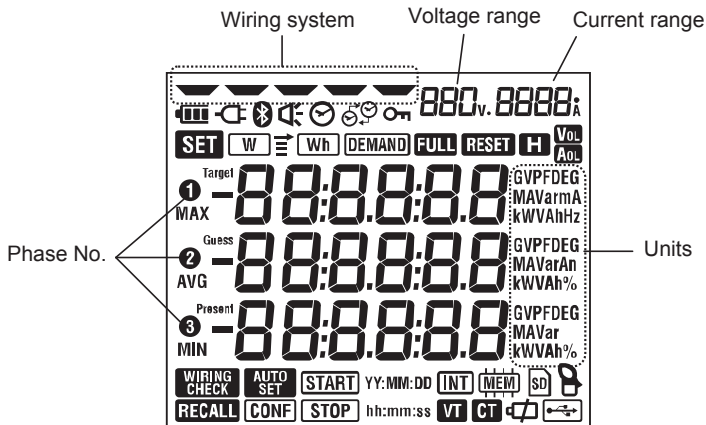













Symbols displayed on the LCD

< All symbols >



< Symbols appear to show the state of the instrument or measurement >

Symbol	Description
	Keys are being locked.
	Preset voltage value is exceeded.
	Preset current value is exceeded.
	Operating with AC power supply.
	Operating with batteries.
	Data hold function is active.
	SET UP Range is selected.
	WIRING CHECK Range is selected.
	Blinks while instantaneous value is being displayed on the LCD.
	Blinks while integration value is being displayed on the LCD.
	Blinks while demand value is being displayed on the LCD.
	Capacity of SD card or internal memory is full.
	DATA CHECK Range is selected.
	Data can be saved in the SD card. * Blinks while saving data.
	USB cord is connected to the terminal. * Blinks during data communication.
	Setting Bluetooth communication.
	Data can be saved in the internal memory. * Blinks while accessing to the memory.
	VT ratio is set to other than "1".
	CT ratio is set to other than "1".

3. Preparations

Battery

KEW6305 operates either an AC power supply or batteries. Capable of performing measurements in an event of AC power interruption, power to the instrument is automatically restored by the batteries installed in the instrument. Size AA alkaline dry-cell batteries (LR6) can be used.

If an AC power supply is interrupted and batteries have not been installed, the instrument will be powered off and the measuring data may be lost.

Indication on screen

Symbol of power supply displayed on each measurement screen changes as follows.

< During AC power supply operation >
AC power supply symbol (☎) appears.

< During battery operation >
Battery symbol (🔋) appears.

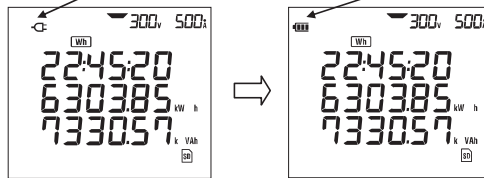

● Battery condition

Battery symbol changes as follows depending on battery condition.

Battery operating time	
	For approx. 15 hours, with new alkaline batteries. * It is reference time and will be shortened if using the backlight or Bluetooth function.
	Batteries are exhausted. (Accuracy of readings cannot be guaranteed.) Depending on the states of measurement, instrument operates as follows automatically. * while saving instantaneous value data (Files are opened.) -> Close the open files. (Data will be saved.) * while measuring integration/ demand values -> Force-quit measurements. (Data will be saved.)

How to install batteries

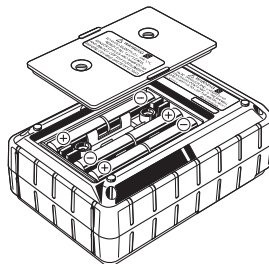

Install batteries in correct polarity as marked inside.

Remove all the batteries if the instrument is to be stored and will not be in use for a long period.

Cord connection



Protective fingerguard

Protective fingerguard:
It is a part providing protection against electrical shock and ensuring the minimum required air and creepage distances.

*When the instrument and the test lead are combined and used together, whichever lower category either of them belongs to will be applied.

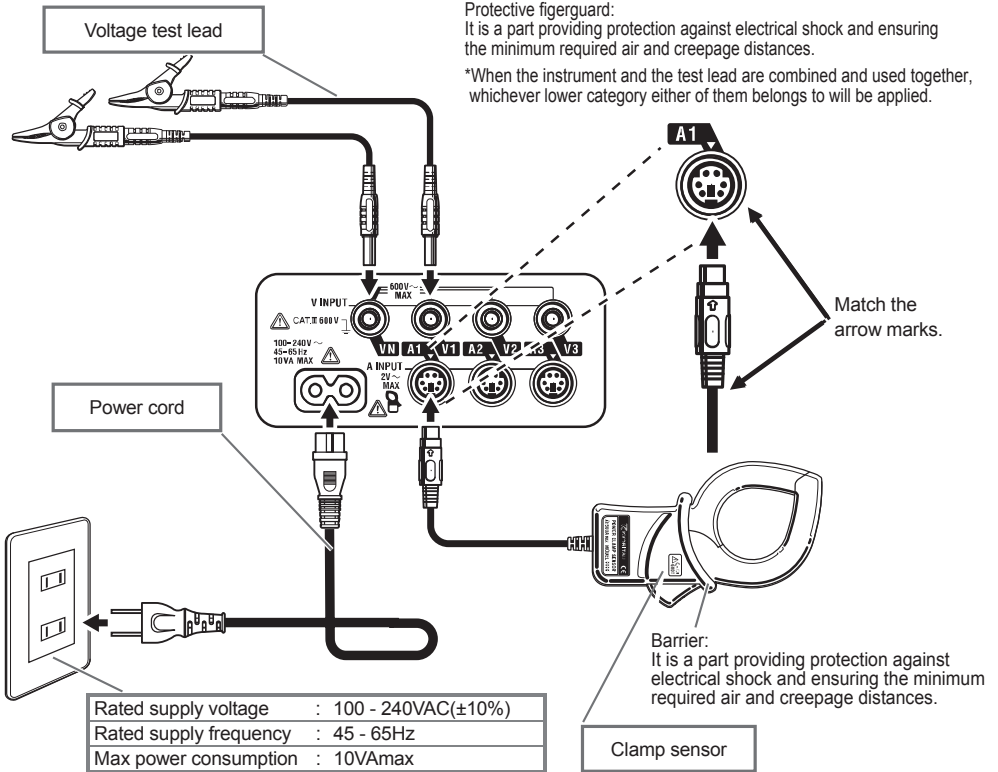

Start-up screen

KEW6305 will be powered on when setting the Function switch to any position other than OFF.

All of the LCD segments will be displayed first, and then model name with version information.

After that, stand-by screen for the selected range will be displayed.

Upon powering on the instrument, self-check routine initiates automatically. Stop using the instrument if error message appear on the LCD after self-check and refer to (**Section 12**) **Troubleshooting** in the full instruction manual.



Error No. (001 – 063)

```

Err.001
}
Err.063
    
```

4. Set-up: **SET UP** Range









Set the Function switch to **SET UP** Range for making various settings.
Settings listed below can be changed. (27 items in total)

List of setting items

Setting	Setting no./ item	Symbol	Details	
Basic setting	01 Wiring system		1P2W(1ch)/ 1P2W(2ch)/ 1P2W(3ch)/ 1P3W/ 3P3W/ 3P3W3A/ 3P4W	
	02 Voltage range		150/ 300/ 600V	
	03 Clamp sensor		50/ 100/ 200/ 500/ 1000/ 3000A type	
	04 Current range	-	-	03 Sensor Range
				50A 1/5/10/25/50A/AUTO
				100A 2/10/20/50/100A/AUTO
200A 4/20/40/100/200A/AUTO				
500A 10/50/100/250/500A/AUTO				
1000A 20/100/200/500/1000A/AUTO				
3000A 300/1000/3000A				
05 VT ratio		0.01 - 9999.99 (can be set by 0.01)		
06 CT ratio		0.01 - 9999.99 (can be set by 0.01)		
Time& Buzzer	07 Date and time		Year:Month:Day:Hour:Minute:Second	
	08 Buzzer		ON / OFF	
Measurement	09 Recording interval		1/ 2/ 5/ 10/ 15/ 20/ 30 sec./ 1/ 2/ 5/ 10/ 15/ 20/ 30 min./ 1 hour	
	10 Specific time period rec. or endless rec.		ON: Specifying start/ stop time (repeatedly recorded) OFF : Record the data continuously	
	11 ¹ Time period setting Time setting		Start and stop time (Year:Month:Day:Hour:Minute:Second)	
	12 ¹ Time period setting Date setting		Year:Month:Day:Hour:Minute:Second	
	13 ² Start of continuous measurement		Year:Month:Day:Hour:Minute:Second	
	14 ² End of continuous measurement		Year:Month:Day:Hour:Minute:Second	
	15 Target demand		Value : 0.1 - 999.9 Unit: W/kW/MW/GW/VA/kVA/MVA/GVA	
	16 Demand measurement cycle		NO/ 10/ 15/ 30 min * Demand measurement will not be performed when "NO" has been selected.	
	17 Demand warning cycle		1/2/5 min. when measurement cycle is 10or15 min., 1/2/5/10/15 min. when measurement cycle is 30 min.	

* 1 : Setting 11& 12 can be changed only when Setting 10 has been set to "ON".

* 2 : Setting 13& 14 can be changed only when Setting 10 has been set to "OFF".

Setting	Setting no./ item	Symbol	Details
SD card/ Internal memory	18 Available space in SD card		Show the available space in the installed SD card in percentage.
	19 SD card Format		ON(Format)/ OFF(Not format)
	20 Available space in Internal memory		Show the available space in the internal memory in percentage.
	21 Internal memory Format		ON(Format)/ OFF(Not format)
Others	22 System reset		ON(Reset)/ OFF(Not reset)
	23 ID number	-	Designate ID no. (00-001 - 99-999)
	24 Setting read		Save no.: 01 - 20
	25 Setting save		Save no.: 01 - 20
	26 Bluetooth		ON/ OFF
	27 V/A Range Auto-switching		ON/ OFF

4-1. Setting procedure

STEP1 Set the Function Switch to **SET UP** Range. (to show the Set-up screen)

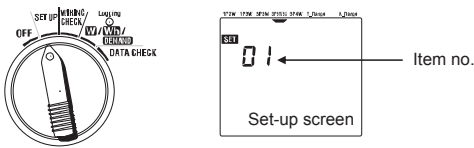

STEP2 Use the Cursor keys and switch the Setting items with Setting no. 01 to 27.

for increasing numbers, for decreasing numbers.

STEP3 Press on the desired Setting no..
(corresponding setting item starts blinking and enters into the setting change mode.)

STEP4 Use the Cursor keys and change settings.

< Example >
Setting no. "01", Setting Item "Wiring system":
Setting: Select any one of 1P2W(1ch)/1P2W(2ch)/1P2W(3ch)/1P3W/3P3W/3P3W3A/3P4W.

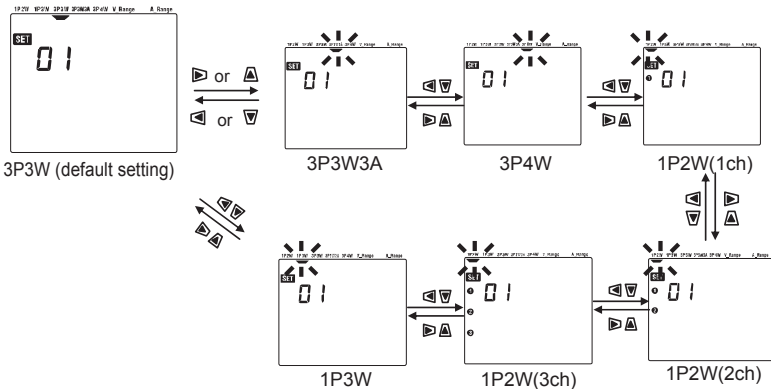

STEP5 Confirm the changed setting.
(Press .)

STEP5 Cancel the change.
(Press .)

Setting completes. Go to STEP 2 for the other settings.

4-2. Wiring system

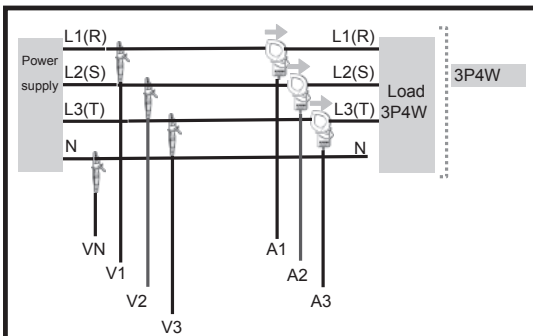
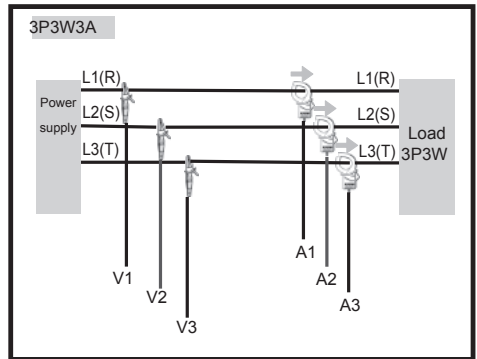
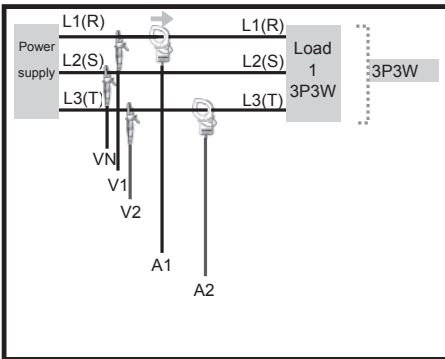
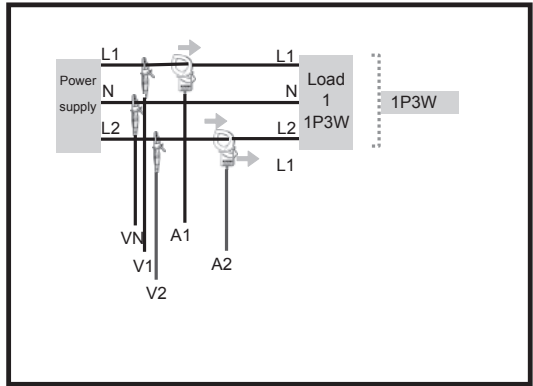
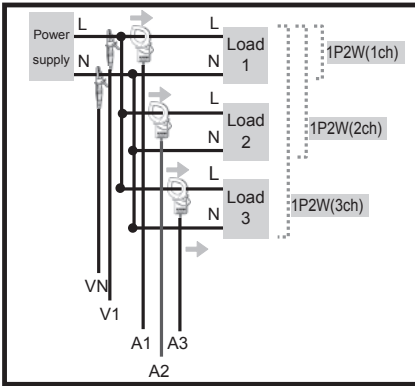

Orientation of Clamp sensor

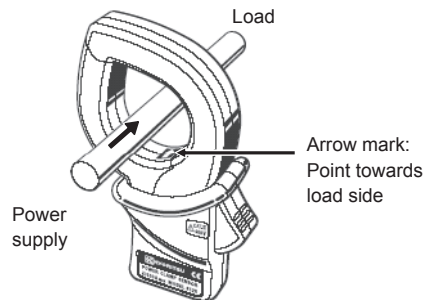

Reverse clamping switches the symbols (+/-) for active power (P).

5. Measurement Ranges

KEW6305 can perform the following three different measurements.

- (a) Instantaneous value measurement (W Range)
- (b) Integration value measurement (Wh Range)
- (c) Demand measurement (DEMAND Range)

Select a desirable Range according to the steps below.

1. Set the Function Switch to **W/Wh/DEMAND** Range.

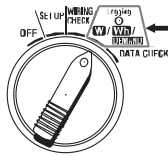

Set the switch to **W/Wh/DEMAND** position.

2. Select a Range

Any one of following symbols blinks on the LCD to show which Range has been selected.



e.g.: When Wh Range is selected, **Wh** symbol blinks.

- (a) Selecting **W** Range

- (1) Use the \leftarrow \rightarrow Keys and select the “**W**” symbol on the LCD.
- (2) Then use the \uparrow \downarrow Keys to switch screens (1- 3) to be displayed.

Screen 1	← “-” symbol blinks on the top
Screen 2	← “-” symbol blinks on the middle
Screen 3	← “-” symbol blinks on the bottom

- (b) Selecting **Wh** or **DEMAND** Range

- (1) Use the \uparrow \downarrow Keys and select the “**W**→” symbol while the Function switch is at the **W** Range position.
- (2) Press the \leftarrow \rightarrow Keys and select the **Wh** or **DEMAND** Range.
(Selecting either “Wh” or “DEMAND” Range is impossible unless “→” symbol is not selected.)
- (3) Use the \uparrow \downarrow Keys and switch the displayed contents.

6. Instantaneous value Measurement: **W** Range

6-1. Steps for measurement

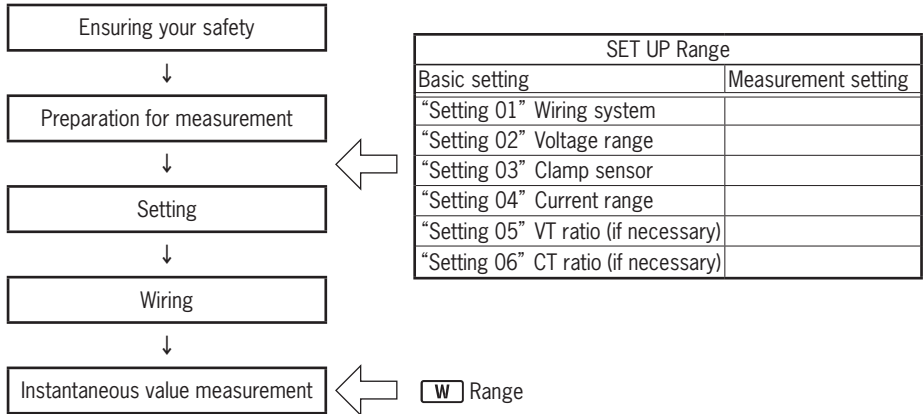

● Parameters for **W** Range

Parameters to be displayed on the LCD			Unit
Voltage (RMS)	V Vi	: average voltage of each phase : voltage of each phase	V
Current (RMS)	A Ai	: average current of each phase : current of each phase	A
Active power	P Polarity :+ (no sign) consumption - (minus) regenerating	: total active power Pi : active power of each phase	W
Reactive power	Q Polarity :+ (no sign) lagging phase - (minus) leading phase	: total reactive power Qi : reactive power of each phase	Var
Apparent power	S	: total apparent power Si: apparent power of each phase	VA
Power factor	PF Polarity :+ (no sign) lagging phase - (minus) leading phase	: power factor of whole system PFi : power factor of each phase	PF
Frequency	f	: frequency of V1	Hz
Neutral current	In	: current on neutral line (3P4W only)	An

* i = 1, 2, 3

6-2. Selecting/switching display contents

Three parameters (max) can be displayed in one screen. (In the example 1-A below, V, A and P are displayed.) Display screen will be different depending on wiring systems.

- e.g. For Three-phase 4-wire “3P4W” (16 screens):

Screen 1-A

		<div style="display: flex; justify-content: space-around; align-items: center;"> ▶▶▶▶▶▶▶▶▶▶ ◀◀◀◀◀◀◀◀◀◀ </div>								
		A	B	C	D	E	F	G	H	
<div style="display: flex; align-items: center; justify-content: center;"> <div style="margin-right: 5px;">▲</div> <div style="margin-right: 5px;">▼</div> </div>	1	(Screen)	(1-A)	(1-B)	(1-C)	(1-D)				
	<div style="border: 1px solid black; padding: 2px; width: 20px; margin: 0 auto;">W</div> <div style="display: flex; align-items: center; justify-content: center; margin-top: 2px;"> ⏏ </div>	Top	V	V1	V2	V3	—	—	—	
	<div style="display: flex; align-items: center; justify-content: center; margin-top: 2px;"> ▲ ↑ Blink </div>	Middle	A	A1	A2	A3				
		Bottom	P	P1	P2	P3				
	2	(Screen)	(2-A)	(2-B)	(2-C)	(2-D)				
<div style="border: 1px solid black; padding: 2px; width: 20px; margin: 0 auto;">W</div> <div style="display: flex; align-items: center; justify-content: center; margin-top: 2px;"> ⏏ </div>	Top	P	P1	P2	P3	—	—	—		
<div style="display: flex; align-items: center; justify-content: center; margin-top: 2px;"> ▲ ↑ Blink </div>	Middle	S	S1	S2	S3					
		Bottom	PF	PF1	PF2	PF3				
	3	(Screen)	(3-A)	(3-B)	(3-C)	(3-D)	(3-E)	(3-F)	(3-G)	(3-H)
<div style="border: 1px solid black; padding: 2px; width: 20px; margin: 0 auto;">W</div> <div style="display: flex; align-items: center; justify-content: center; margin-top: 2px;"> ⏏ </div>	Top	V1	A1	P1	PF1	S1	Q1	f	VL12	
<div style="display: flex; align-items: center; justify-content: center; margin-top: 2px;"> ▲ ↑ Blink </div>	Middle	V2	A2	P2	PF2	S2	Q2	In	VL23	
		Bottom	V3	A3	P3	PF3	S3	Q3	—	VL31

- * Screen 1-A is displayed after powering on the instrument.
- * Use **▶** or **◀** Key to switch screens listed above in a horizontal direction.
(from 1-A to 1-D, 2-A to 2-D and 3-A to 3-G)
- * Use **▲** or **▼** Key to switch screens listed above in a vertical direction. (from 1-A to 3-A only)
On any of screens 1-B to 1-D, press **▲** to switch screen to 3-A or **▼** to switch screen to 2-A.
On any of screens 2-B to 2-D, press **▲** to switch screen to 1-A or **▼** to switch screen to 3-A.
On any of screens 3-B to 3-G, press **▲** to switch screen to 2-A or **▼** to switch screen to 1-A.
- * Phase no. **①**, **②**, **③** will be displayed on the LCD.
(e.g.: On screen 1-B, only one Phase no. symbol “**①**” is displayed and on screen 3-A all Phase no. symbols “**①**”, **②**, **③**” are displayed. However, none of them is displayed on screen 1-A, 2-A and 3-G.)
- * Screen 3-A shows Phase voltage and Screen 3-H Line voltage.

- For the other wiring systems:
Screens can be switched in the same way as described in the previous page.

WIRING	Screen	A	B	C	D	E	F	G		
3P3W3A	1	Top	V(avg)	V1	V2	V3	-	-	-	
		Middle	A(avg)	A1	A2	A3				
		Bottom	P	P1	P2	P3				
	2	Top	P	P1	P2	P3	-	-	-	
		Middle	S	S1	S2	S3				
		Bottom	PF	PF1	PF2	PF3				
	3	Top	V1	A1	P1	PF1	S1	Q1	f	
		Middle	V2	A2	P2	PF2	S2	Q2	-	
		Bottom	V3	A3	P3	PF3	S3	Q3	-	
3P3W	1	Top	V(avg)	V1	V2	-	-	-	-	
		Middle	A(avg)	A1	A2					
		Bottom	P	P1	P2					
	2	Top	P	P1	P2	-	-	-	-	
		Middle	S	S1	S2					
		Bottom	PF	PF1	PF2					
	3	Top	V1	A1	P1	PF1	S1	Q1	f	
		Middle	V2	A2	P2	PF2	S2	Q2	-	
		Bottom	-	-	-	-	-	-	-	
1P3W	1	Top	V(avg)	V1	V2	-	-	-	-	
		Middle	A(avg)	A1	A2					
		Bottom	P	P1	P2					
	2	Top	P	P1	P2	-	-	-	-	
		Middle	S	S1	S2					
		Bottom	PF	PF1	PF2					
	3	Top	V1	A1	P1	PF1	S1	Q1	f	
		Middle	V2	A2	P2	PF2	S2	Q2	-	
		Bottom	-	-	-	-	-	-	-	
1P2W (3ch)	1	Top	V	V	V	-	-	-	-	
		Middle	A(avg)	A1	A2					A3
		Bottom	P	P1	P2					P3
	2	Top	P	P1	P2	P3	-	-	-	
		Middle	S	S1	S2	S3				
		Bottom	PF	PF1	PF2	PF3				
	3	Top	V1	A1	P1	PF1	S1	Q1	f	
		Middle	-	A2	P2	PF2	S2	Q2	-	
		Bottom	-	A3	P3	PF3	S3	Q3	-	
1P2W (2ch)	1	Top	V	V	V	-	-	-	-	
		Middle	A(avg)	A1	A2					
		Bottom	P	P1	P2					
	2	Top	P	P1	P2	-	-	-	-	
		Middle	S	S1	S2					
		Bottom	PF	PF1	PF2					
	3	Top	V1	A1	P1	PF1	S1	Q1	f	
		Middle	-	A2	P2	PF2	S2	Q2	-	
		Bottom	-	-	-	-	-	-	-	
1P2W (1ch)	1	Top	V	-	-	-	-	-	-	
		Middle	A							
		Bottom	P							
	2	Top	P	-	-	-	-	-	-	
		Middle	S							
		Bottom	PF							
	3	Top	V	A	P	PF	S	Q	f	
		Middle	-	-	-	-	-	-	-	
		Bottom	-	-	-	-	-	-	-	

6-3. Data saving

Instantaneous values (**W** Range) can be saved by manual operation only.

[Saving procedure]

- (1) File no. screen is displayed and data will be saved when pressing the **SAVE** Key during a measurement at **W** Range.

Screen at **W** Range

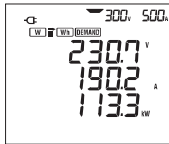

SAVE

File no. screen

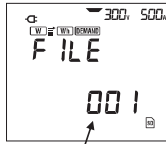

File no.

Screen at **W** Range

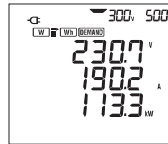

- (2) Another press of **SAVE** Key saves another data in the preceding file.
(In this case, File no. is not displayed but the buzzer sounds like “pi”.)

7. Integration value Measurement: **Wh** Range

7-1. Steps for measurement

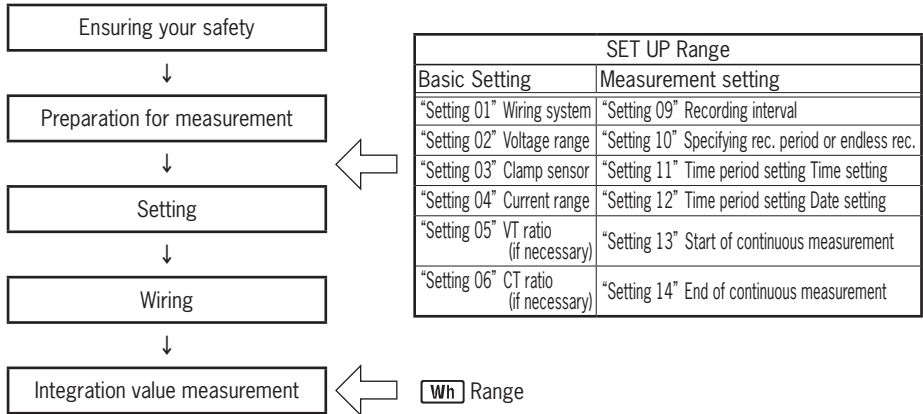

● Parameters for **Wh** Range

Parameters to be displayed on the LCD		Unit
Active energy (consumption)	WP : Total active energy WP1/WP2/WP3 : Active energy of each phase	Wh
Apparent energy (consumption)	WS : Total apparent energy WS1/WS2/WS3 : Apparent energy of each phase	VAh
Integration elapsed time	TIME : Hour; Min.; Sec. Hour; Min. Hour	—

7-2. How to start/ stop measurement

● To start/ stop measurement manually

Hold down the **START/STOP** Key for over 2 sec.

Wh Range

● To start/ stop measurement at the preset date&time

Configure the settings for “Setting 10/11/12”, and then press the **START/STOP** Key.



File no. screen is displayed for about 2 sec.

- Manual operation : Pressing the **START/STOP** Key starts measurement anytime.
- Automatic operation : KEW6305 enters into stand-by mode and wait until the preset start time comes.

The Status indicator LED blinks when the instrument is in stand-by mode and it stays on when measurement starts.

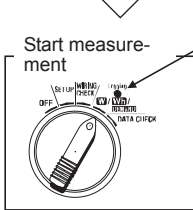

LED

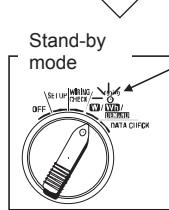

LED blinks

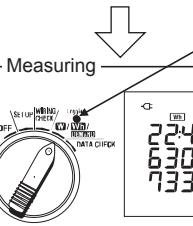

LED lights up

- * Display is updated every 1 sec.
- * Data will be saved at the interval selected at “Setting 09”.
- * While performing measurement, select the **W** Range to view instantaneous values and the **SET UP** Range to check the details of settings.

Stop measurement

Manual operation

Hold down the **START/STOP** Key for over 2 sec.

Automatic operation

Measurement stops automatically when the preset date& time comes.

The status indicator LED goes off when measurement stops (or **file is closed**).

* When the destination to save data has been set to the internal memory, “**MEM**” symbol is displayed on the screen instead of “**SD**” symbol.

Integration values remain displayed on the LCD when measurement ends.

Press the “**ESC**” Key at least 2 sec to select “dEL” and clear the display if the displayed values will not be used in further measurements.

7-3. How to switch screens/ save data

- Screens and switching method
 < e.g. Three-phase 4-wire “3P4W” >

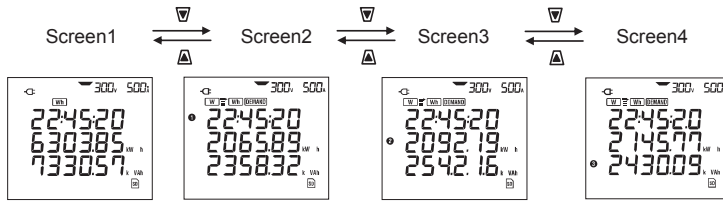

<For the other wiring systems>

Wiring system (“Setting 01”)		Displayed at	Parameters to be displayed			
			Screen 1	Screen 2	Screen 3	Screen 4
* Single-phase 2-wire (1ch)	1P2W(1ch)	Top Middle Bottom	TIME WP WS	—	—	—
* Single-phase 2-wire (2ch)	1P2W(2ch)	Top	TIME	TIME	TIME	—
* Single-phase 3-wire	1P3W	Middle	WP	WP1	WP2	—
* Three-phase 3-wire	3P3W	Bottom	WS	WS1	WS2	—
* Single-phase 2-wire (3ch)	1P2W(3ch)	Top	TIME	TIME	TIME	TIME
* Three -phase 3-wire 3A	3P3W3A	Middle	WP	WP1	WP2	WP3
* Three -phase 4-wire	3P4W	Bottom	WS	WS1	WS2	WS3

- Saving data (Data will be saved automatically.)

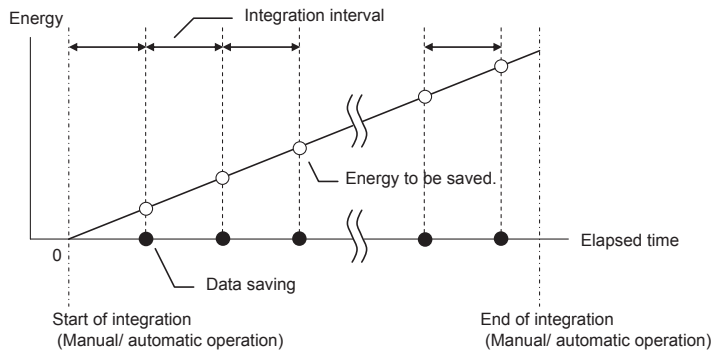

8. Demand Measurement : **DEMAND** Range

8-1. Steps for measurement

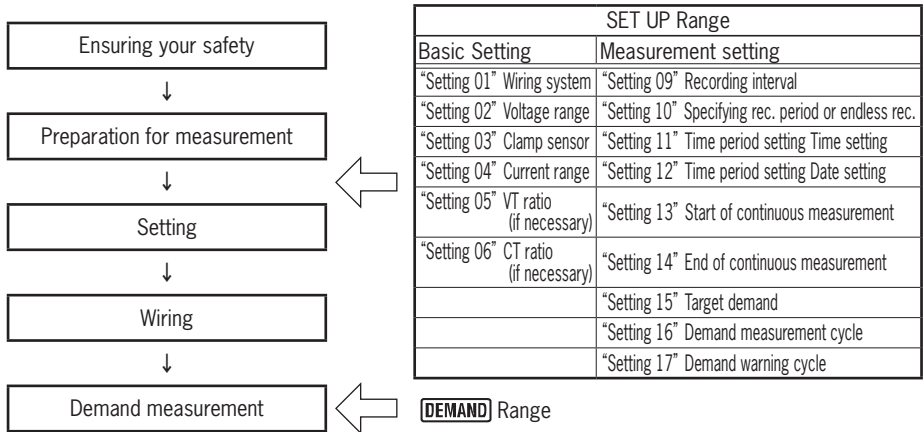

* Measured demand values will be displayed on the LCD at the start of measurement.

● Parameters for **DEMAND** Range

Parameters to be displayed on the LCD	Unit
Target value	W
Predicted value	W
Present value	W
Load factor	%
Demand time	—
Max. demand value	W
When max. demand value measured	—

8-2. How to start/ stop measurement

- To start/ stop measurement manually

Hold down the  Key for over 2 sec.

DEMAND
Range

- To start/ stop measurement at the preset date&time

Configure the settings for “Setting 14/15”, and then press the  Key.

File no. screen is displayed for about 2 sec.



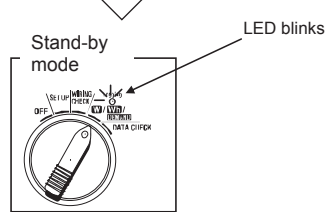
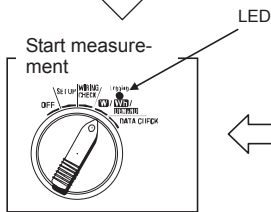

- Manual operation : Pressing the  Key starts measurement anytime.
- Automatic operation : KEW6305 enters into stand-by mode and wait until the preset start time comes.

The Status indicator LED blinks when the instrument is in stand-by mode and it stays on when measurement starts.

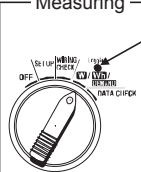

Measuring

- * Display is updated every 1 sec.
- * Data will be saved at the interval selected at “Setting 13”.
- * Buzzer sounds when a predicted value exceeds a target value set at “Setting 15” in the pre-set period set at “Setting 17”.
- * While performing measurement, select the **W** Range to view instantaneous values, **Wh** Range to view integration values and **SET UP** Range to check the details of settings.

Stop measurement



Manual operation

Hold down the  Key for over 2 sec.

Automatic operation

Measurement stops automatically when the preset date& time comes.

The status indicator LED goes off when measurement stops (or **file is closed**).

* When the destination to save data has been set to the internal memory, “” symbol is displayed on the screen instead of “” symbol.

Integration values remain displayed on the LCD when measurement ends.

Press the “” Key at least 2 sec to select “dEL” and clear the display if the displayed values will not be used in further measurements.

8-3. Screens/ saving data

- Parameters displayed on screens and switching method

Screen 1	Screen 2	Screen 3
Top : Target value	Top : Demand time	Top : Date when max. demand value measured
Middle : Predicted value	Middle : Load factor	Middle : Time when max. demand value measured
Bottom : Present value	Bottom : Present value	Bottom : Max. demand value

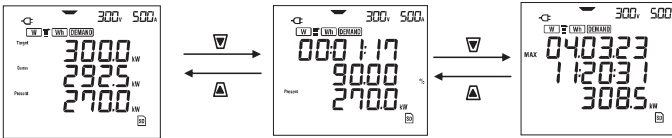

- Saving data (Data will be saved automatically.)

< Demand measurement with this instrument >

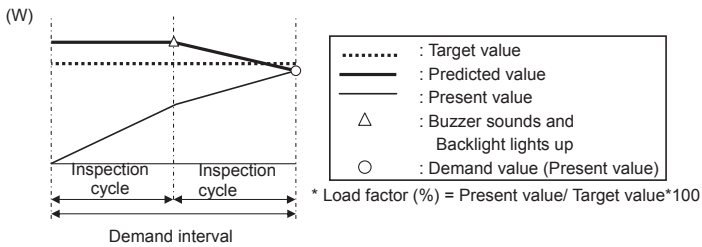

< Max demand value and data saving point >

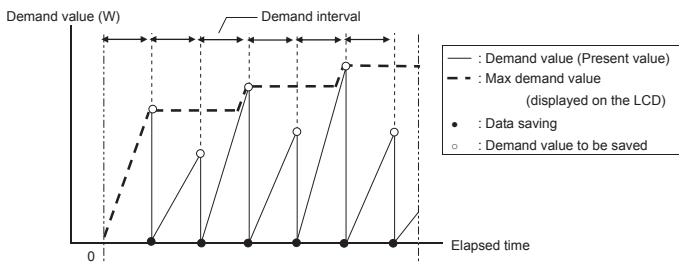

9. SD card/ Saved data

9-1. SD card compatibility

This instrument supports 1/ 2Gbyte SD cards.

● Max number of saved data

Destination to save data		SD card		Internal memory
Capacity		1GB	2GB	3MB
Manual saving (W)		approx. 3.3 million results	approx. 6.7 million results	approx. 10,000 results
Auto-saving at preset interval	1 sec	approx. 8 days	approx. 17 days	approx. 33 min.
	1 min	approx. 16 months	approx. 33 months	approx. 33 hours
	30 min	3 years or more		approx. 42 days
Max number of file		511		4

* In case that no file has been contained in SD card.

● File name

File name is assigned automatically.

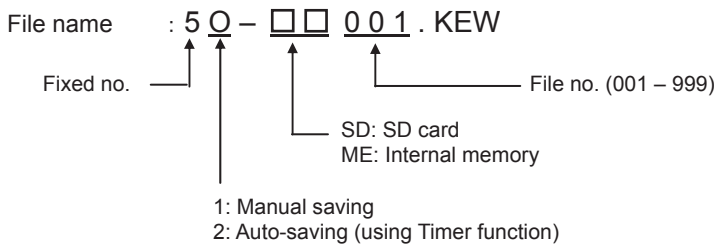

● Parameters to be saved

The table below shows the parameters to be saved corresponding to each measurement range.
(Parameters to be saved are different depending on wiring systems.)

Manual saving : parameters in column 1 only
(except for max/ min/ avg of each parameter)

Auto-saving : all parameters in column 1 & 2

Parameters to be saved												
1	Voltage (RMS) Vi : voltage of each phase Vi max : max. Vi values Vi min : min. Vi values Vi avg : avg. Vi values											
	Current (RMS) Ai : current of each phase Ai max : max. Ai values Ai min : min. Ai values Ai avg : avg. Ai values											
	Active power P : total active power P max : max. P value P min : min. P value P avg : avg. P value <table style="float: right; border: none;"> <tr> <td>Pi</td><td>: active power of each phase</td></tr> <tr> <td>Pi max</td><td>: max. Pi values</td></tr> <tr> <td>Pi min</td><td>: min. Pi values</td></tr> <tr> <td>Pi avg</td><td>: avg. Pi values</td></tr> </table>	Pi	: active power of each phase	Pi max	: max. Pi values	Pi min	: min. Pi values	Pi avg	: avg. Pi values			
	Pi	: active power of each phase										
	Pi max	: max. Pi values										
	Pi min	: min. Pi values										
	Pi avg	: avg. Pi values										
Reactive power Q : total reactive power Q max : max. Q value Q min : min. Q value Q avg : avg. Q value <table style="float: right; border: none;"> <tr> <td>Qi</td><td>: reactive power of each phase</td></tr> <tr> <td>Qi max</td><td>: max. Qi values</td></tr> <tr> <td>Qi min</td><td>: min. Qi values</td></tr> <tr> <td>Qi avg</td><td>: avg. Qi values</td></tr> </table>	Qi	: reactive power of each phase	Qi max	: max. Qi values	Qi min	: min. Qi values	Qi avg	: avg. Qi values				
Qi	: reactive power of each phase											
Qi max	: max. Qi values											
Qi min	: min. Qi values											
Qi avg	: avg. Qi values											
Apparent power S : total apparent power S max : max. S value S min : min. S value S avg : avg. S value <table style="float: right; border: none;"> <tr> <td>Si</td><td>: apparent power of each phase</td></tr> <tr> <td>Si max</td><td>: max. Si values</td></tr> <tr> <td>Si min</td><td>: min. Si values</td></tr> <tr> <td>Si avg</td><td>: avg. Si values</td></tr> </table>	Si	: apparent power of each phase	Si max	: max. Si values	Si min	: min. Si values	Si avg	: avg. Si values				
Si	: apparent power of each phase											
Si max	: max. Si values											
Si min	: min. Si values											
Si avg	: avg. Si values											
Power factor PF : power factor of whole system PF max : max. PF value PF min : min. PF value PF avg : avg. PF value <table style="float: right; border: none;"> <tr> <td>PFi</td><td>: power factor of each phase</td></tr> <tr> <td>PFi max</td><td>: max. PFi values</td></tr> <tr> <td>PFi min</td><td>: min. PFi values</td></tr> <tr> <td>PFi avg</td><td>: avg. PFi values</td></tr> </table>	PFi	: power factor of each phase	PFi max	: max. PFi values	PFi min	: min. PFi values	PFi avg	: avg. PFi values				
PFi	: power factor of each phase											
PFi max	: max. PFi values											
PFi min	: min. PFi values											
PFi avg	: avg. PFi values											
Frequency f : frequency of V1 f max : max. f value f min : min. f value f avg : avg. f value <table style="float: right; border: none;"> <tr> <td style="background-color: #cccccc;">Neutral current</td><td>In</td><td>: current on neutral line</td></tr> <tr> <td></td><td>In max</td><td>: max. In value</td></tr> <tr> <td></td><td>In min</td><td>: min. In value</td></tr> <tr> <td></td><td>In avg</td><td>: avg. In value</td></tr> </table>	Neutral current	In	: current on neutral line		In max	: max. In value		In min	: min. In value		In avg	: avg. In value
Neutral current	In	: current on neutral line										
	In max	: max. In value										
	In min	: min. In value										
	In avg	: avg. In value										
2	Active energy (consumption) (regenerating) (overall) +WP : total active energy (consumption) +WPi : active energy (consumption) of each phase -WP : total active energy (regenerating) -WPi : active energy (regenerating) of each phase #WP : total active energy (overall) #WPI : active energy (overall) of each phase											
	Apparent energy (consumption) (regenerating) (overall) +WS : total apparent energy (consumption) +WSi : apparent energy (consumption) of each phase -WS : total apparent energy (regenerating) -WSi : apparent energy (regenerating) of each phase #WS : total apparent energy (overall) #WSi : apparent energy (overall) of each phase											
	Reactive energy (consumption) +WQ : total reactive energy (consumption)											
	Demand value #DEM : total demand value TARGET : target demand value <table style="float: right; border: none;"> <tr> <td>#DEMi</td><td>: demand value of each phase</td></tr> </table>	#DEMi	: demand value of each phase									
#DEMi	: demand value of each phase											

* i = 1, 2, 3

where, "max." and "avg." mean maximum and average values during an interval.

9-2. Data transfer

1. SD card and USB

Data in SD card or internal memory can be transferred to PC using USB connection or SD card slot/reader.

	Method of transfer	
	USB	Card reader
SD card data (file)	△ ^{*1}	○
Internal memory data (file)	○	—

*1 : It is recommended to transfer the data with big size by use of SD card since transfer of such data via USB takes time. (transfer time : approx 320MB/ hour)

* As to the manipulation of SD cards, please refer to the instruction manual attached to the card.

* In order to save data without any problem, make sure to delete the files other than the data measured with this instrument from the SD card.

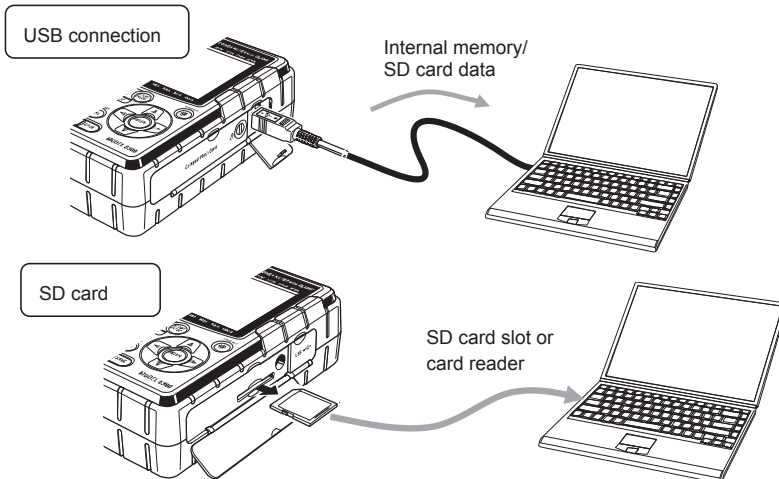

2. Bluetooth

Measuring data can be checked on android devices in real-time via Bluetooth communication.

It is necessary to enable Bluetooth function prior to using Bluetooth communication. (Setting No. 26: Bluetooth)

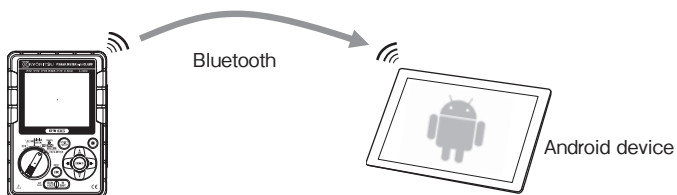

* Before starting to use this function, download the special application “KEW Smart” from the Internet site.

The application “KEW Smart” is available on download site for free. (An Internet access is required.)

10. Wiring check: **WIRING CHECK** Range

10-1. Checking procedure

Select the **WIRING CHECK** Range for checking proper connection.

STEP1 After connections are complete, set the Function switch to the **WIRING CHECK** Range. Then present voltage, current, power factor and electric power (instantaneous value) are displayed on the LCD as shown in the table below.

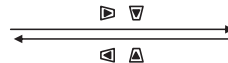
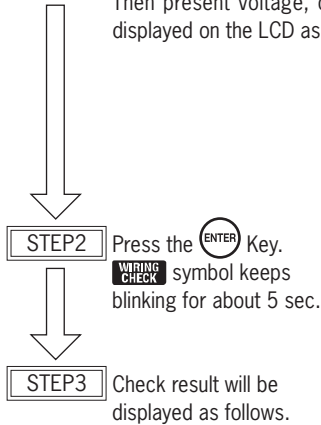

Wiring system (Setting no. 01)	Display position	Items to be displayed					
		Screen 1	Screen 2	Screen 3	Screen 4	Screen 5	Screen 6
3P4W 3P3W3A	Top	f	V1	A1	P1	PF1	DEG(V1)
	Middle	V(avg)	V2	A2	P2	PF2	DEG(V2)
	Bottom	A(avg)	V3	A3	P3	PF3	DEG(V3)
3P3W 1P3W	Top	f	V1	A1	P1	PF1	DEG(V1)
	Middle	V(avg)	V2	A2	P2	PF2	DEG(V2)
	Bottom	A(avg)	—	—	—	—	—
1P2W (3ch)	Top	f	V	A1	P1	PF1	—
	Middle	V	—	A2	P2	PF2	—
	Bottom	A(avg)	—	A3	P3	PF3	—
1P2W (2ch)	Top	f	V	A1	P1	PF1	—
	Middle	V	—	A2	P2	PF2	—
	Bottom	A(avg)	—	—	—	—	—
1P2W (1ch)	Top	f	V	A1	P1	PF1	—
	Middle	V	—	—	—	—	—
	Bottom	A1	—	—	—	—	—

Everything is OK.

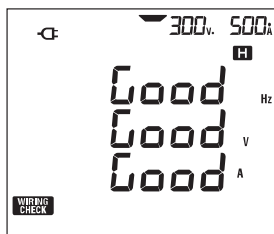

Error is found.



* Check results may be affected if great power factors (0.5 or less) exist at the measurement sites.

10-2. Criteria of judgment and cause

Check	Criteria of Judgment	Cause
Frequency	Frequency of V1 is within 45 - 65Hz.	- Voltage clip is firmly connected to the DUT? - Measuring too high harmonic components?
Voltage input	Voltage input is 60% or more of (Voltage Range x VT).	- Voltage clip is firmly connected to the DUT? - Voltage test leads are firmly connected to the Voltage input terminal on the instrument?
Voltage balance	Voltage input is within $\pm 20\%$ of reference voltage (V1) * (not checked in single-phase wiring)	- Settings are matched with the wiring system under test? - Voltage clip is firmly connected to the DUT? - Voltage test leads are firmly connected to the Voltage input terminals on the instrument?
Voltage phase	Phase of voltage input is within $\pm 10^\circ$ of reference value (proper vector).	- Voltage test leads are properly connected? (Connected to proper channels?)
Current input	Current input is 10% or more and 110% or less of (Current Range x CT).	- Clamp sensors are firmly connected to the Power input terminals on the instrument? - Setting for Current Range is appropriate for input levels?
Current phase	- PFi (absolute value) is 0.5 or more. (3P3W3A : $0 \leq \text{PFi}$) - Pi is positive value.	- Arrow mark on the Clamp sensor and the orientation of flowing current coincide with each other? (Power supply to Load) - Clamp sensors are connected properly?

11. Data check: **DATA CHECK** Range

Past 10 data (including the latest one) can be recalled and checked on the LCD.
 Select the **DATA CHECK** Range for checking the data.

Data No.	01	02	...	09	10
Saved data	Latest data	Two before the latest		Nine before the latest	Ten before the latest

STEP1 After connections are complete, set the Function switch to the **DATA CHECK** Range. Then "RECALL" symbol appears and the latest data (No. 01) is displayed on the LCD.

Select the **DATA CHECK** Range.

RECALL symbol appears.

LCD shows the saved data.

Data no. is displayed.

STEP2 Use the Keys and select any Data no..

STEP3 Use the Keys and switch screens.
 Screens can be switched at **DATA CHECK** Range are as follows.
 Use the Keys and select any Data no..



Wiring system (Setting no. 01)	Display position	Items to be displayed					
		Screen 1 (Date& time)	Screen 1 (Voltage)	Screen 1 (Current)	Screen 4 (Power)	Screen 5 (Power)	Screen 5 (DEMAND)
3P4W 3P3W3A	Top	YY.MM.DD	V1	A1	P1	TIME	Target value
	Middle	hh:mm:ss	V2	A2	P2	+WP	—
	Bottom	—	V3	A3	P3	+WS	Present value
3P3W 1P3W	Top	YY.MM.DD	V1	A1	P1	TIME	Target value
	Middle	hh:mm:ss	V2	A2	P2	+WP	—
	Bottom	—	—	—	—	+WS	Present value
1P2W (3ch)	Top	YY.MM.DD	V1	A1	P1	TIME	Target value
	Middle	hh:mm:ss	—	A2	P2	+WP	—
	Bottom	—	—	A3	P3	+WS	Present value
1P2W (2ch)	Top	YY.MM.DD	V1	A1	P1	TIME	Target value
	Middle	hh:mm:ss	—	A2	P2	+WP	—
	Bottom	—	—	—	—	+WS	Present value
1P2W (1ch)	Top	YY.MM.DD	V	A	P	TIME	Target value
	Middle	hh:mm:ss	—	—	—	+WP	—
	Bottom	—	—	—	—	+WS	Present value

MEMO

DISTRIBUTOR

Kyoritsu reserves the rights to change specifications or designs described in this manual without notice and without obligations.

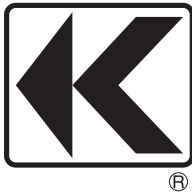

KYORITSU ELECTRICAL INSTRUMENTS WORKS, LTD.

2-5-20, Nakane, Meguro-ku,
Tokyo, 152-0031 Japan
Phone: +81-3-3723-0131
Fax: +81-3-3723-0152
Factory: Ehime, Japan