

FLUKE®

CNX 3000

Wireless Multimeter

Users Manual

August 2012

© 2012 Fluke Corporation. All rights reserved. Specifications are subject to change without notice.

All product names are trademarks of their respective companies.

LIMITED WARRANTY AND LIMITATION OF LIABILITY

This Fluke product will be free from defects in material and workmanship for three years from the date of purchase. This warranty does not cover fuses, disposable batteries, or damage from accident, neglect, misuse, alteration, contamination, or abnormal conditions of operation or handling. Resellers are not authorized to extend any other warranty on Fluke's behalf. To obtain service during the warranty period, contact your nearest Fluke authorized service center to obtain return authorization information, then send the product to that Service Center with a description of the problem.

THIS WARRANTY IS YOUR ONLY REMEDY. NO OTHER WARRANTIES, SUCH AS FITNESS FOR A PARTICULAR PURPOSE, ARE EXPRESSED OR IMPLIED. FLUKE IS NOT LIABLE FOR ANY SPECIAL, INDIRECT, INCIDENTAL OR CONSEQUENTIAL DAMAGES OR LOSSES, ARISING FROM ANY CAUSE OR THEORY. Since some states or countries do not allow the exclusion or limitation of an implied warranty or of incidental or consequential damages, this limitation of liability may not apply to you.

Fluke Corporation
P.O. Box 9090
Everett, WA 98206-9090
U.S.A.

Fluke Europe B.V.
P.O. Box 1186
5602 BD Eindhoven
The Netherlands

Table of Contents

Title	Page
Introduction	1
How to Contact Fluke	1
Safety Information	1
Hazardous Voltage	5
Test Lead Alert	5
Battery Saver	5
MIN MAX AVG Record Mode	6
Display Hold	7
Yellow Button	7
Display Backlight	7
Manual and Auto Range	7
Power-Up Options	8
Features	9
AC Zero Input Behavior of True-rms Meters	13
Basic Measurements	13

AC and DC Voltage Measurements	13
Volts/Hertz Ratio	15
Resistance Measurements	16
Capacitance Measurements	17
Continuity Test.....	18
AC or DC Current Measurements	19
Diode Test	21
Frequency Measurement	23
Remote Operation	25
Radio Frequency Data	25
Discovery of Modules.....	26
How to Unbind a Module from the Product	29
How to Set the Product to Module Mode	29
Maintenance	30
General Maintenance.....	30
Fuse Test.....	31
Battery and Fuse Replacement	32
Service and Parts	34
Specifications	36
Detailed Specifications.....	38
AC Voltage.....	38
DC Voltage, Continuity, Resistance, Diode Test, and Capacitance	39
AC and DC Current.....	40
Frequency.....	40
Frequency Counter Sensitivity	41
Input Characteristics	42
MIN MAX Recording	42

List of Tables

Table	Title	Page
1.	Symbols.....	4
2.	Power-Up Options	8
3.	Inputs	9
4.	Rotary Switch Positions.....	10
5.	Pushbuttons	11
6.	Replaceable Parts	34
7.	Accessories	36

List of Figures

Figure	Title	Page
1.	AC and DC Voltage Measurements	14
2.	Volt/Hertz Ratio	15
3.	Resistance Measurements	16
4.	Capacitance Measurements	17
5.	Continuity Tests.....	18
6.	AC and DC Current Measurements.....	20
7.	Diode Test	22
8.	Frequency Measurement.....	24
9.	Module Binding Procedure	28
10.	Fuse Test	31
11.	Battery and Fuse Replacement	33
12.	Replacement Parts	35

Introduction

⚠⚠ Warning

To prevent possible electrical shock, fire, or personal injury, read all safety information before you use the Product.

The CNX 3000 Wireless Multimeter (the Product) is a True-rms Digital Multimeter.

How to Contact Fluke

To contact Fluke, call one of the following telephone numbers:

- Technical Support USA: 1-800-44-FLUKE (1-800-443-5853)
- Calibration/Repair USA: 1-888-99-FLUKE (1-888-993-5853)
- Canada: 1-800-36-FLUKE (1-800-363-5853)
- Europe: +31 402-675-200
- Japan: +81-3-6714-3114
- Singapore: +65-6799-5566
- Anywhere in the world: +1-425-446-5500

Or, visit Fluke's website at www.fluke.com.

To register your product, visit <http://register.fluke.com>.

To view, print, or download the latest manual supplement, visit <http://us.fluke.com/usen/support/manuals>.

Safety Information

The Product complies with:

- ANSI/ISA-82.02.01
- CAN/CSA-C22.2 No. 61010-1-12: 3rd Edition
- UL 61010-1: 3rd Edition
- IEC/EN 61010-1:2010
- FCC Part 15 Subpart C Section 15.207, 15.209, 15.249 FCCID: T68-FWCS
- IC:6627A-FWCS
- Measurement Category III, 1000V, Pollution Degree 2
- Measurement Category IV, 600V, Pollution Degree 2

A **Warning** identifies conditions and procedures that are dangerous to the user. A **Caution** identifies conditions and procedures that can cause damage to the Product or the equipment under test.

A list of symbols used on the Product and in this manual is in Table 1.

⚠⚠ Warning

To prevent possible electrical shock, fire, or personal injury:

- Carefully read all instructions.
- Use the Product only as specified, or the protection supplied by the Product can be compromised.
- Limit operation to the specified measurement category, voltage, or amperage ratings.
- Do not use the Product around explosive gas, vapor, or in damp or wet environments.
- Do not touch voltages > 30 V ac rms, 42 V ac peak, or 60 V dc.
- Do not exceed the Measurement Category (CAT) rating of the lowest rated individual component of a Product, probe, or accessory.
- Measure a known voltage first to make sure that the Product operates correctly.
- Do not use, and disable the Product if it is damaged.
- Do not work alone.
- Comply with local and national safety codes. Use personal protective equipment (approved rubber gloves, face protection, and flame-resistant clothes) to prevent shock and arc blast injury where hazardous live conductors are exposed.
- Replace the batteries when the low battery indicator shows to prevent incorrect measurements.
- The battery door must be closed and locked before you operate the Product.

- **Do not use the Product if it operates incorrectly.**
- **Examine the case before you use the Product. Look for cracks or missing plastic. Carefully look at the insulation around the terminals.**
- **Use only correct measurement category (CAT), voltage, and amperage rated probes, test leads, and adapters for the measurement.**
- **Do not use test leads if they are damaged. Examine the test leads for damaged insulation, exposed metal, or if the wear indicator shows. Check test lead continuity.**
- **Keep fingers behind the finger guards on the probes.**
- **Do not touch the probes to a voltage source when the test leads are connected to the current terminals.**
- **Connect the common test lead before the live test lead and remove the live test lead before the common test lead.**
- **Remove all probes, test leads, and accessories that are not necessary for the measurement.**

Table 1. Symbols









Symbol	Description	Symbol	Description
	Risk of Danger. Important information. See Manual.		Hazardous voltage.
	Conforms to European Union directives.		Conforms to relevant Australian EMC requirements.
	Conforms to relevant North American Safety Standards.		Fuse
	Battery		Double insulation.
CAT III	Measurement Category III is applicable to test and measuring circuits connected to the distribution part of the building's low-voltage MAINS installation.	CAT IV	Measurement Category IV is applicable to test and measuring circuits connected at the source of the building's low-voltage MAINS installation.
CAT II	Measurement Category II is applicable to test and measuring circuits connected directly to utilization points (socket outlets and similar points) of the low-voltage MAINS installation.		

Table 1. Symbols (cont.)

Symbol	Description
	This product complies with the WEEE Directive (2002/96/EC) marking requirements. The affixed label indicates that you must not discard this electrical/electronic product in domestic household waste. Product Category: With reference to the equipment types in the WEEE Directive Annex I, this product is classed as category 9 "Monitoring and Control Instrumentation" product. Do not dispose of this product as unsorted municipal waste. Go to Fluke's website for recycling information.

Hazardous Voltage

The display shows \downarrow and the hazardous voltage indicator illuminates red when a hazardous voltage (≥ 30 V) is present on the input of the Product

Test Lead Alert

The display shows LEAD for a second when you turn the function switch to or from the mA position to remind you to make sure the test leads are in the correct terminals.

Battery Saver

The Product goes into "Sleep mode" and turns off the display if there is no function change or button pushed for 20 minutes. To turn off the sleep mode, push  while you turn on the Product. The sleep mode is always turned off for a MIN MAX AVG record session and when remote modules are shown in the display.

MIN MAX AVG Record Mode

The MIN MAX AVG record mode records the minimum and maximum input values, and calculates a running average of all measurements. The Product beeps when a new high or low is sensed.

Note

For dc functions, accuracy is the specified accuracy of the measurement function, ± 12 counts for changes longer than 250 ms in duration.

For ac functions, accuracy is the specified accuracy of the measurement function ± 40 counts for changes longer than 900 ms in duration.

To start a MIN MAX AVG record session:

1. Make sure the Product is set to the correct measurement function and on the correct range. Autorange is disabled while in a MIN MAX AVG record session.
2. Push **MINMAX**, **Min Max** and Max show at the top of the display. The measurement in the display is the maximum value measured. It will change only when a new maximum value is sensed.
3. To pause MIN MAX AVG record, push **HOLD**. **HOLD** shows in the display while record is paused.

Recorded values are not deleted. To continue record session, push **HOLD**.

4. To exit and erase the MIN, MAX, and AVG values, push **MINMAX** for 1 second or turn the rotary switch.
5. To see the other recorded values (minimum and average), push **MINMAX**. Each push of the button shows a different recorded value. The value shown in the display is identified with Max, Min, or Avg to the right of the MIN MAX icon.

Note

Battery save or sleep mode is turned off in MIN MAX AVG record mode.

Display Hold

Warning

To prevent possible electrical shock, fire, or personal injury, do not use the HOLD function to measure unknown potentials. When HOLD is turned on, the display does not change when a different potential is measured.

In the display hold mode, the Product holds the DMM measurement in the display. All wireless module measurements continue to update. To hold a measurement in the display, push **HOLD**. The display shows **HOLD** when display hold is turned on.

Push **HOLD** again to stop hold mode and show measurements in the display.

Yellow Button

Push the YELLOW button () to set the Product to a different measurement function. The different functions are shown in yellow around the rotary switch. Frequency, mV ac, capacitance, diode test, and mA dc are functions of the Product set with the yellow button.

Display Backlight

Push  to turn on and turn off the backlight. The backlight automatically turns off after 2 minutes.

Manual and Auto Range

The Product can be set to manual or auto range. In autorange, the Product sets the range so the input is shown with the best resolution. Manual range lets you set the range.

When you turn on the Product, it is set to autorange and **Auto** shows in the display. To set the Product to manual range, push **RANGE**.





Note

*You cannot change range when the Product is in the MIN MAX AVG record mode or in display hold mode. If you push **RANGE** in one of these modes, the Product will beep twice to alert you to an invalid operation.*

Power-Up Options

To set a power-up option, hold down the button shown in Table 2 while you turn on the Product.

Table 2. Power-Up Options

Button	Power-Up Option
	Turns off the beeper.
 (YELLOW)	Turns off battery save ("Sleep mode"). POFF shows in the display for a second.
	Turns off 2 minute backlight timeout. LOFF shows in the display for a second.
	Sets the Product to the module mode. See the "How to Set the Product to Module Mode."

Features

Tables 3 through 5 are lists of Product features with descriptions.

Table 3. Inputs

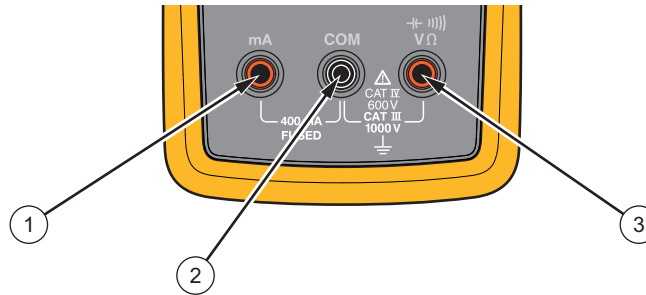

gxr001.eps

Terminal	Description
①	mA - Input for 3.00 mA to 400.0 mA current measurements and current frequency.
②	COM - Return terminal for all measurements.
③	* $\text{V}\Omega$ - Input for voltage, resistance, diode, capacitance, and voltage frequency.

Table 4. Rotary Switch Positions















Switch Position	Function
	DC voltage from 1 mV to 1000 V. Push  to measure frequency from 2 Hz to 99.99 kHz
	AC voltage measurement from 60.0 mV to 1000 V. Push  to measure frequency from 2 Hz to 99.99 kHz. Push  again to measure Volts/Hertz.
	DC voltage measurements from 1 mV to 600 mV. Push  to measure ac voltage from 6 mV to 600 mV. ^[1]
	Resistance measurements from 0.1 Ω to 50 M Ω . Push  to measure capacitance from 1 nF to 9999 μ F.
	Continuity. Beeper turns on at <25 Ω and turns off at >250 Ω . Push  for diode test. Shows OL above 2.0 V.
	AC current measurements from 3.00 mA to 400 mA. Push  to measure dc current from 3.00 mA to 400 mA. ^[1] Push  again to measure frequency from 2 Hz to 9.99 kHz.
<p>[1] This function will stay in ac or dc when the function switch is moved to another position and back to this function. Even when turned to off and back to this function.</p>	

Table 5. Pushbuttons







Button	Switch Position	Function
	<p>Hz ~ V</p> <p>Hz ≡ V</p> <p>~ ≡ mV</p> <p>⊕ Ω</p> <p>⊕)))</p> <p>~ ≡ mA Hz</p>	<p>Selects frequency.</p> <p>Selects frequency.</p> <p>Selects ac millivolts. ^[1]</p> <p>Selects capacitance.</p> <p>Selects diode test.</p> <p>Push once to select dc milliamps. Push twice to select ac frequency. ^[1]</p>
<p>RANGE</p>	<p>All positions</p>	<p>Sets the Product to manual range and scrolls through each range. Push for 1 second to set the Product to autorange.</p>
<p>HOLD</p>	<p>All positions</p>	<p>Freezes the display</p>

Table 5. Pushbuttons (cont.)

Button	Switch Position	Function
	Not related to switch position	Push once to turn on the backlight and push again to turn off the backlight. The backlight turns off automatically after 2 minutes.
	All positions	Starts the MIN MAX record function. Steps the display through MAX, MIN, AVG (average), and input signal measurement. Push for 1 second to stop MIN MAX record.
	Not related to switch position	Selects/deselects the highlighted wireless module in the display. Hold for 1 second to bind all selected modules to the Product and stop the discovery procedure. ^[2]
	Not related to switch position	Moves the highlight in the display to the next wireless module shown in the display. ^[2]
	Not related to switch position	Turns on the radio and starts the module discovery procedure.  shows in the display when the radio is on. Turns off the radio when the radio is on. ^[2]
<p>[1] This function will stay in ac or dc when the function switch is moved to another position and back to this function. Even when turned to off and back to this function.</p> <p>[2] This button is used when the Product connects with a wireless module. See the “Discovery of Modules” section to learn more.</p>		

AC Zero Input Behavior of True-rms Meters

Average responding meters can accurately measure only pure sinewaves. A True-rms meter can accurately measure distorted waveform signals. A minimum input voltage is necessary for Calculating True-rms converters to make a measurement. Because of this minimum input, true-rms meter specifications are only good for 1 % to 100 % of range. Non-zero digits that are shown on a true-rms meter when the test leads are open or are shorted are possible. This has no effect on the ac measurement accuracy of signals that are more than 1 % of range.

Unspecified input levels on the lowest ranges are:

AC voltage less than 1 % of 600 mV ac or 6 mV ac.

AC current less than 5 % of 60 mA ac or 3 mA ac.

Basic Measurements

⚠⚠ Warning

To prevent possible electrical shock, fire, or personal injury, disconnect power and discharge all high-voltage capacitors before you measure resistance, continuity, capacitance, or a diode junction.

The figures that follow show how to make basic measurements with the Product.

When you connect the test leads to the circuit or device, connect the common (COM) test lead before the live lead. When you remove the test leads, remove the live lead before the common test lead.

AC and DC Voltage Measurements

The voltage ranges are 600.0 mV, 6.000 V, 60.00 V, 600.0 V, and 1000 V. To set the 600.0 mV dc or ac range, turn the function switch to \tilde{mV} . Push  to toggle the Product between millivolts dc and millivolts ac. Refer to Figure 1 to measure ac or dc voltage.

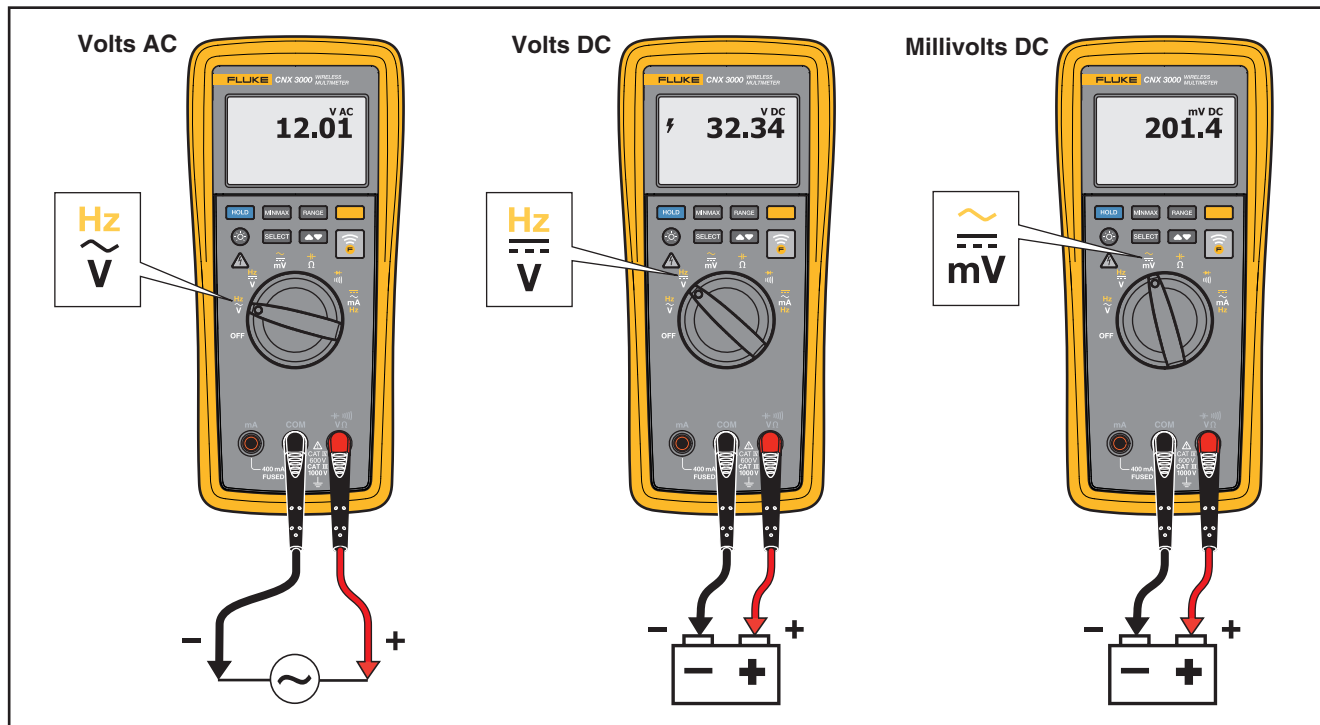

Figure 1. AC and DC Voltage Measurements

gxr002.eps

Volts/Hertz Ratio

The Product can show the ratio of volts to frequency of an ac signal. Set the Product as shown in Figure 2 to show Volts/Hertz ratio.

When the Product is set to the Volts/Hz function, the voltage range is set to manual. If the voltage increases to a value larger than the range, the Product shows **OL** in the display. If the voltage drops to less than 5 % of the range, the value shown in the display can be invalid. Set the Product as shown in Figure 2 to measure volts/Hz.

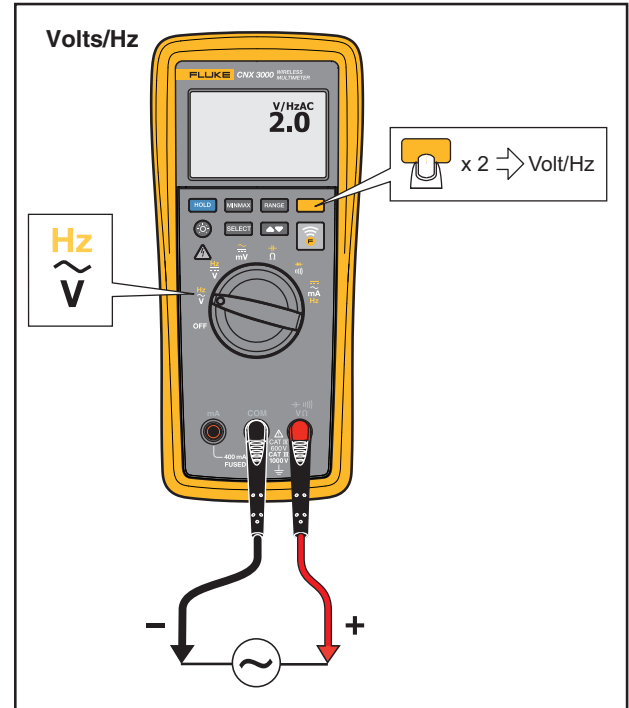

gxr011.eps

Figure 2. Volt/Hertz Ratio

Resistance Measurements

⚠ ⚠ Warning

To prevent possible electrical shock, fire, or personal injury, disconnect power and discharge all high-voltage capacitors before you measure resistance, continuity, capacitance, or a diode junction.

The Product sends a small current through the circuit for resistance measurements. Because the current flows through all possible paths between the probes, the resistance measured is the total resistance of all paths between the probes.

The resistance ranges are 600.0 Ω , 6.000 k Ω , 60.00 k Ω , 600.0 k Ω , 6.000 M Ω , and 50.00 M Ω . Set the Product as show in Figure 3 to measure resistance.

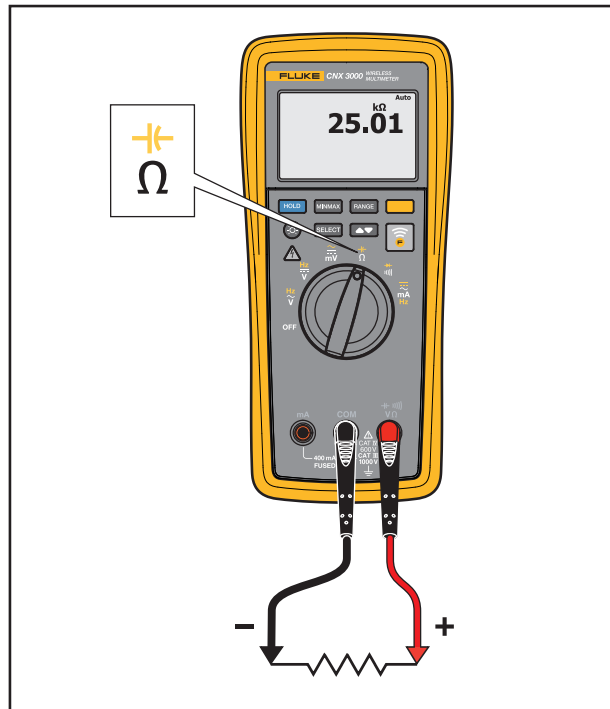

gxr003.eps

Figure 3. Resistance Measurements

Capacitance Measurements

⚠⚠ Warning

To prevent possible electrical shock, fire, or personal injury, disconnect power and discharge all high-voltage capacitors before you measure resistance, continuity, capacitance, or a diode junction.

Capacitance ranges are 1,000 nF, 10.00 μ F, 100.0 μ F, and 9999 μ F. To measure capacitance, set up the Product as shown in Figure 4.

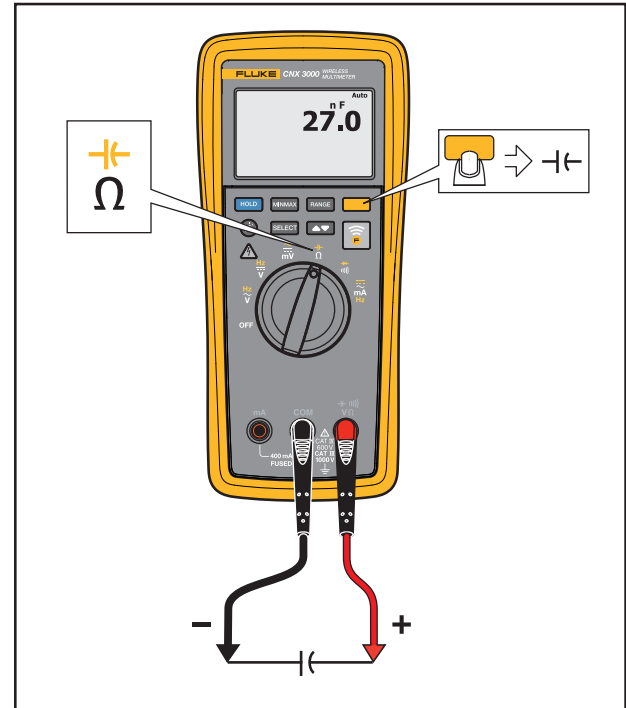

gxr004.eps

Figure 4. Capacitance Measurements

Continuity Test

⚠⚠ Warning

To prevent possible electrical shock, fire, or personal injury, disconnect power and discharge all high-voltage capacitors before you measure resistance, continuity, capacitance, or a diode junction.

The continuity test uses a beeper that sounds when a closed circuit is sensed. The beeper lets you do continuity tests without the necessity to look at the display. To do a continuity test, set up the Product as shown in Figure 5.

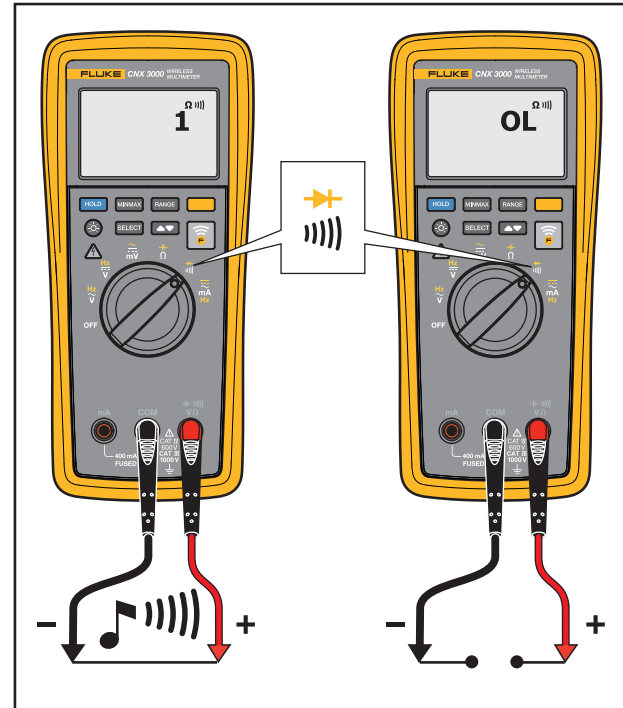

gxr005.eps

Figure 5. Continuity Tests

AC or DC Current Measurements

⚠⚠ Warning

To prevent possible electrical shock, fire, or personal injury:

- **Remove circuit power before you connect the Product in the circuit when you measure current. Connect the Product in series with the circuit.**
- **Limit operation to the specified measurement category, voltage, or amperage ratings.**

⚠ Caution

To prevent possible damage to the Product or the equipment under test:

- **Do a fuse test before current measurements. See “Fuse Test”.**
- **Use the correct terminals, function, and range for all measurements.**
- **Do not put the probes across (in parallel with) a circuit or component when the test leads are connected to the current terminals.**

Turn off circuit power, break the circuit, put the Product in series, and then turn on circuit power.

The current ranges are 60.00 mA and 400.0 mA. Set the Product as shown in Figure 6 to measure ac and dc current. Push  to toggle the Product between milliamps ac and milliamps dc.

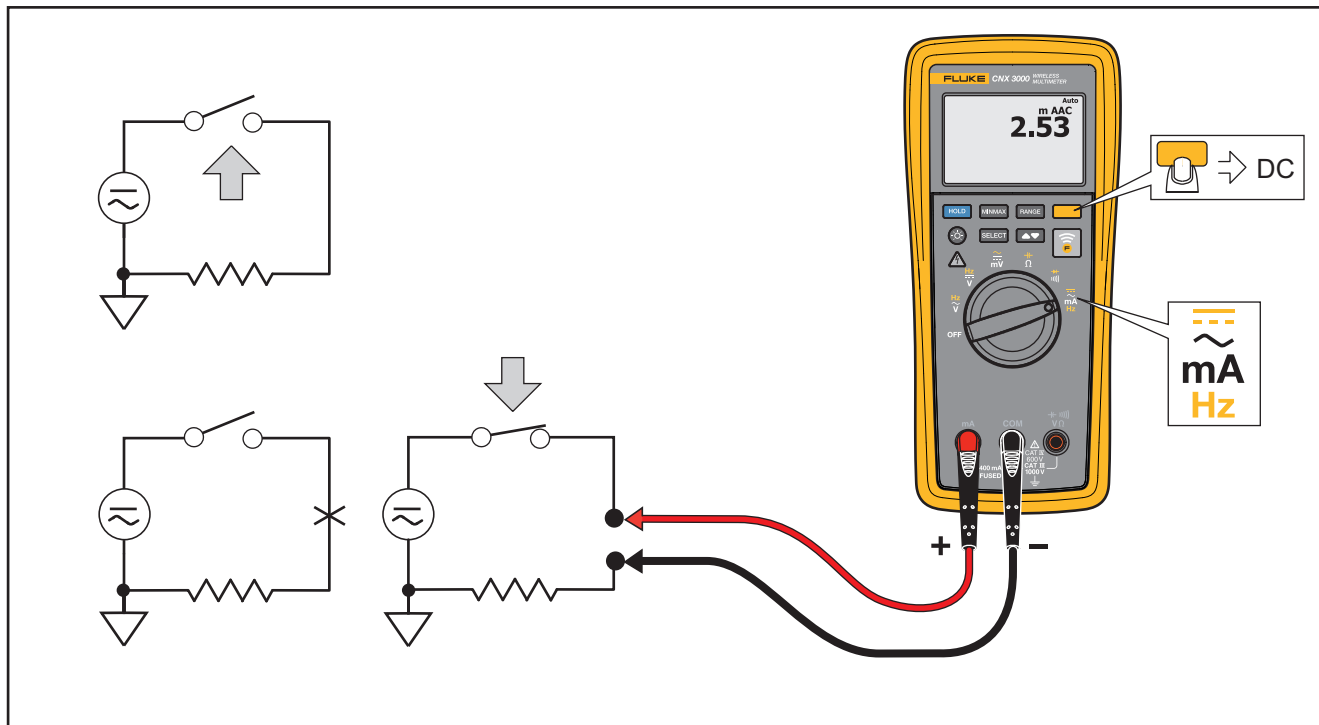

Figure 6. AC and DC Current Measurements

gxr007.eps

Diode Test

⚠⚠ Warning

To prevent possible electrical shock, fire, or personal injury, disconnect power and discharge all high-voltage capacitors before you measure resistance, continuity, capacitance, or a diode junction

Do a diode test on diodes, transistors, silicon controlled rectifiers (SCRs), and other semiconductor devices. The function sends a current through the semiconductor junction and then measures the voltage drop across the junction. A good silicon junction drops between 0.5 V and 0.8 V.

To do a diode test on a diode out of circuit, set up the Product as shown in Figure 7. For forward-bias measurements on a semiconductor component, put the red test lead on the positive terminal of the component and put the black test lead on the negative terminal of the component.

In a circuit, a good diode has a forward-bias measurement of 0.5 V to 0.8 V. A reverse-bias measurement includes the resistance of other pathways between the probes.

A short beep sounds if the diode is good (<0.85 V). A continuous beep sounds if the measurement is ≤ 0.100 V or short circuit. The display shows "OL" if the diode is open.

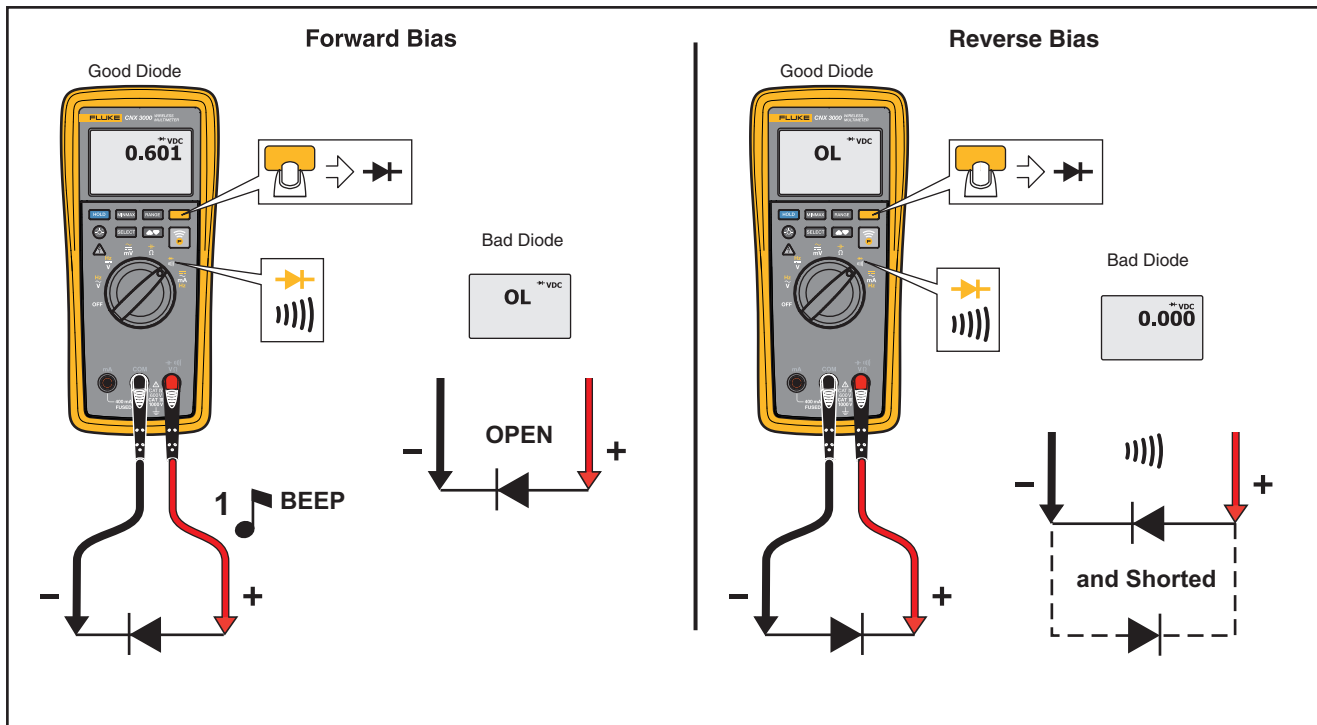

Figure 7. Diode Test

gxr006.eps

Frequency Measurement

A frequency measurement is a count of the number of times an ac voltage or current signal passes through a threshold point each second.

The Product autoranges to one of four frequency ranges: 99.99 Hz, 999.9 Hz, 9.999 kHz, and 99.99 kHz.

Below are some hints for frequency measurements:

- If a measurement shows 0 Hz or is not stable, the input signal can be below or near a trigger level. A lower range increases the sensitivity of the Product and can usually repair these problems.
- An input signal with distortion can cause a frequency measurement to be higher than usual. The distortion can cause the frequency counter to sense multiple triggers. A higher voltage range decreases the input sensitivity and can correct this problem. In general, the lowest frequency is the correct one.

Set up the Product as shown in Figure 8 to measure frequency.

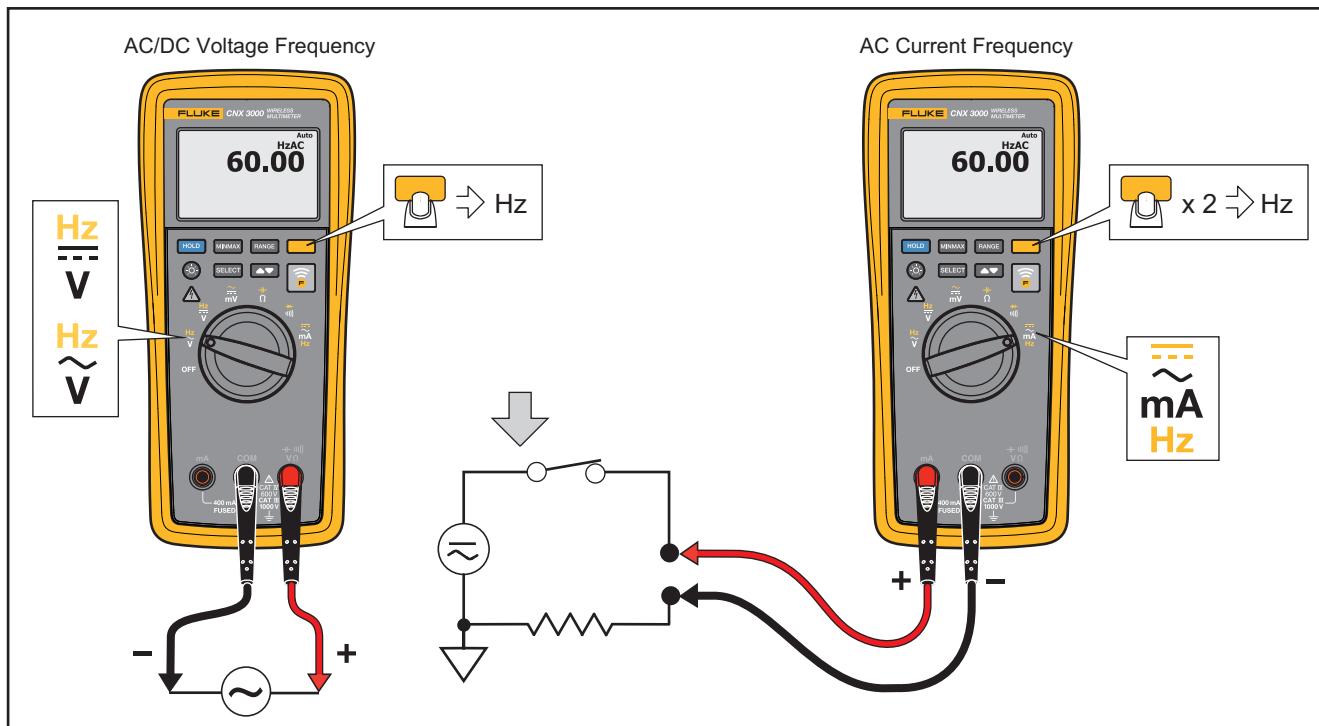

gxr008.eps

Figure 8. Frequency Measurement

Remote Operation

The Product uses low-power 802.15.4 wireless technology to show measurements from a maximum of three CNX 3000 Series Wireless Modules. One of the wireless modules can be a CNX 3000 Wireless Multimeter. The Product cannot control other DMMs or modules. The wireless radio does not cause interference with meter measurements.

Radio Frequency Data

Note

Changes or modifications to the wireless 2.4 GHz radio not expressly approved by Fluke Corporation could void the user's authority to operate the equipment.

This Product complies with Part 15 of the FCC Rules. Operation is subject to the two conditions that follow: (1) this device can not cause interference, and (2) this device must accept any interference, including interference that can cause undesired operation of the device.

Class B digital device: A digital device that is marketed for operation in a residential environment notwithstanding use in commercial, business and industrial environments. Examples of such devices include, but are not limited to, personal computers, calculators, and equivalent electronic devices that are marketed for operation by the general public.

The Meter was tested and found to comply with the limits for a Class B digital device, pursuant to Part 15 of the FCC Rules. These limits are designed to provide reasonable protection against harmful interference in a residential installation. This equipment generates, uses, and can radiate radio frequency energy and, if not installed and used in accordance with the instructions, can cause harmful interference to radio communications. However, there is no guarantee that interference will not occur in a particular installation. If this equipment does cause harmful interference to radio or television reception, which can be determined by turning the equipment off and on, the user is encouraged to try to correct the interference by one or more of the measures that follow:



- Reorient or relocate the receiving antenna.
- Increase the separation between the equipment and receiver.
- Consult the dealer or an experienced radio/TV technician for help.

The term "IC:" before the radio certification number only signifies the device meets Industry's Canada technical specifications.

Discovery of Modules

The term “discovery” in this manual refers to a procedure the Product does to look for compatible radio signals emitted by CNX 3000 Series Wireless Modules. The term bind or bound means the Product has made a wireless connection to a module.

Before you start the discovery procedure, make sure the radio in each module to bind to is turned on. (() must show in the display of each module.

When you first turn on the Product, the radio is off. Push () to turn on the radio and start the discovery procedure. (() shows in the display when the radio is turned on.  flashes in the display while the Product searches for the radio signal of other modules.

When a module is discovered by the Product, that module is given an ID number. The Product starts with 1 and sets wireless module ID numbers in sequence to ten. The ID number and the module model number are shown in the display of the Product. The ID number is also shown in the module display.

When the Product completes the discovery procedure,  stops flashing in the display.

Note

If modules are not discovered after 2 minutes, the radio turns off.

At the end of the discovery procedure, all discovered modules shown in the display have a black number on a grey background. See Figure 9. This shows the modules to which the Product is bound. Although the display can only show three modules, the Product can discover and temporarily bind to a maximum of 10 modules.

Note

To bind a module to the Product after the discovery procedure has completed, you must turn off the radio. Turn on the radio again to start the discovery procedure.

The number of the module at the top of the list flashes to show it is highlighted. Push  to move the highlight to the next module in the list.

The Product stays in the module selection mode for approximately 2 minutes. To select a module to bind to the Product:

1. Push  until you highlight the module to bind.

Note

The radio button () on the module highlighted in the list flashes at a faster rate. This helps identify the highlighted module.

2. Push **SELECT**. The number of the selected module will change to a grey number on a black background. See Figure 9.
3. Do steps 1 and 2 again for each module to bind to the Product. The Product can bind to a maximum of three modules.
4. You can wait for the module selection time to complete or push and hold  for 2 seconds to end the module selection mode.

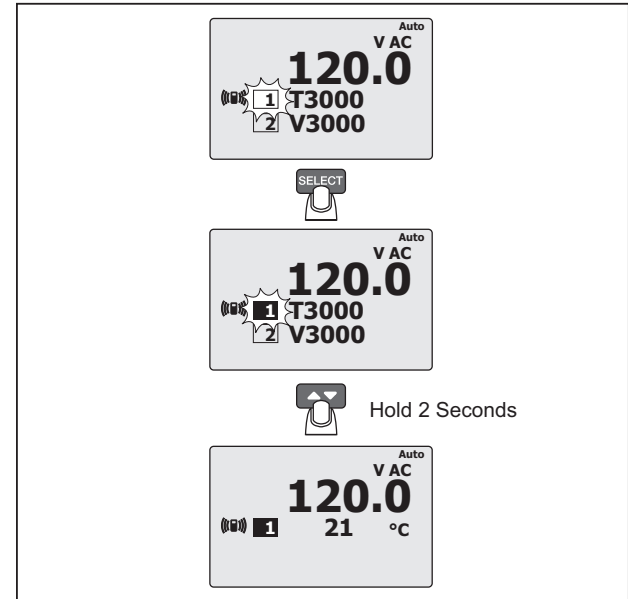

gxr013.eps



Figure 9. Module Binding Procedure

When the module selection mode ends, all modules that were set to bind, show in the display. All modules not selected go out of view.

Note



If you do not select modules, all modules shown in the display are bound to the Product when the module selection mode ends.

The model number of each bound module is replaced with the module measurement. The radio button on the Product and each module bound to the Product, flashes one time in a 5 second interval. The radio button on each non-bound module does not flash.

You can identify which measurement in the display of the Product belongs to which module with the ID number set when the module bound with the Product. Look for the module with the same ID number in its display. To help identify which module is shown in the Product display when the module display cannot be seen, push  to select a module in the list. The radio button () on the module the measurement in the Product display represents flashes at a faster rate.

How to Unbind a Module from the Product

You can use one of three different procedures to unbind a module from the Product.

- Turn off the module.
- Push  on the module to turn off the radio in the module. The module stays on to continue measurements.
- Push  on the Product to select the module you want to unbind and then push **SELECT**. All other modules stay bound to the Product.

How to Set the Product to Module Mode

You can set the Product to operate as a module so its measurements can be shown on different DMM setup as a master. To set the Product to the module mode:

1. Push and hold .
2. Turn on the Product.
3. Release  after **MOD** shows in the display.

Note

The radio is always turned on when the Product is in the module mode.

When the radio on a different DMM is turned on and the discovery procedure starts, the Product is discovered and a number shows in the display of the Product.

Maintenance

⚠⚠ Warning

To prevent a possible electrical shock or personal injury:

- Have an approved technician repair the Meter.
- Do not operate the Product with covers removed or the case open. Hazardous voltage exposure is possible.
- Use only specified replacement parts.
- Remove the input signals before you clean the Product.

General Maintenance

Clean the case with a damp cloth and weak detergent. Do not use a solvent or cleaners with abrasives.

Dirt or moisture in the terminals can cause incorrect measurements. To clean the terminals:

1. Turn off the Meter and remove all test leads.
2. Shake out dirt that can possibly be in the terminals.
3. Soak a clean swab with weak detergent and water.
4. Move the swab around in each terminal.

5. Dry each terminal with canned air to push the water and detergent out of the terminals.

⚠⚠ Warning

To prevent electrical shock or personal injury, remove the test leads and all input signals before you replace the batteries or fuses. To prevent damage or injury, install **ONLY** specified replacement parts shown in Table 6.

Fuse Test

To do a fuse test:

1. Set the function switch to $\frac{\Omega}{\Omega}$.
2. Connect a test lead to the $\frac{\Omega}{\Omega}$ jack as shown in Figure 10.
3. Touch the other end of the test lead to the mA jack.

A good fuse will show a resistance of 12Ω or less. Replace the fuse if the resistance is higher or **OL** is shown.

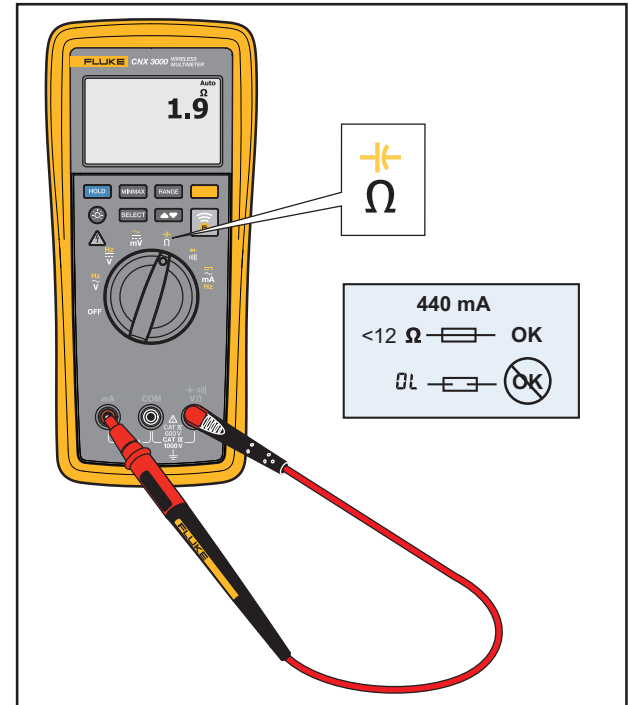

Figure 10. Fuse Test

gxr009.eps

Battery and Fuse Replacement

⚠⚠ Warning

To prevent possible electrical shock, fire, or personal injury:

- **Replace a blown fuse with exact replacement only for continued protection against arc flash.**
- **Use only specified replacement fuses.**
- **Remove the batteries if the Product is not used for an extended period of time, or if stored in temperatures above 50 °C. If the batteries are not removed, battery leakage can damage the Product.**
- **Repair the Product before use if the battery leaks.**
- **Be sure that the battery polarity is correct to prevent battery leakage.**
- **Batteries contain hazardous chemicals that can cause burns or explode. If exposure to chemicals occurs, clean with water and get medical aid.**

To replace the batteries:

1. Turn off the Product and remove all test leads.
2. Lift the tilt stand up as shown in Figure 11.
3. Turn the battery-door latch until the unlock symbol (🔓) aligns with the arrow.
4. Lift off the battery door.
5. Remove the three AA batteries and replace them with new ones. Use the correct battery orientation.
6. Install the battery door.
7. Turn the battery-door latch until the locked symbol (🔒) aligns with the arrow.

To replace the fuse:

1. Turn off the Product and remove all test leads.
2. As shown in Figure 11, remove six screws from the case bottom.
3. Pull the case bottom from the case top.
4. Remove the fuse from its holder and replace it with a 440 mA, 1000 V FAST fuse with a minimum interrupt rating of 10,000 A. Use only Fluke PN 943121.

To reassemble the Product, do the steps in the opposite sequence.

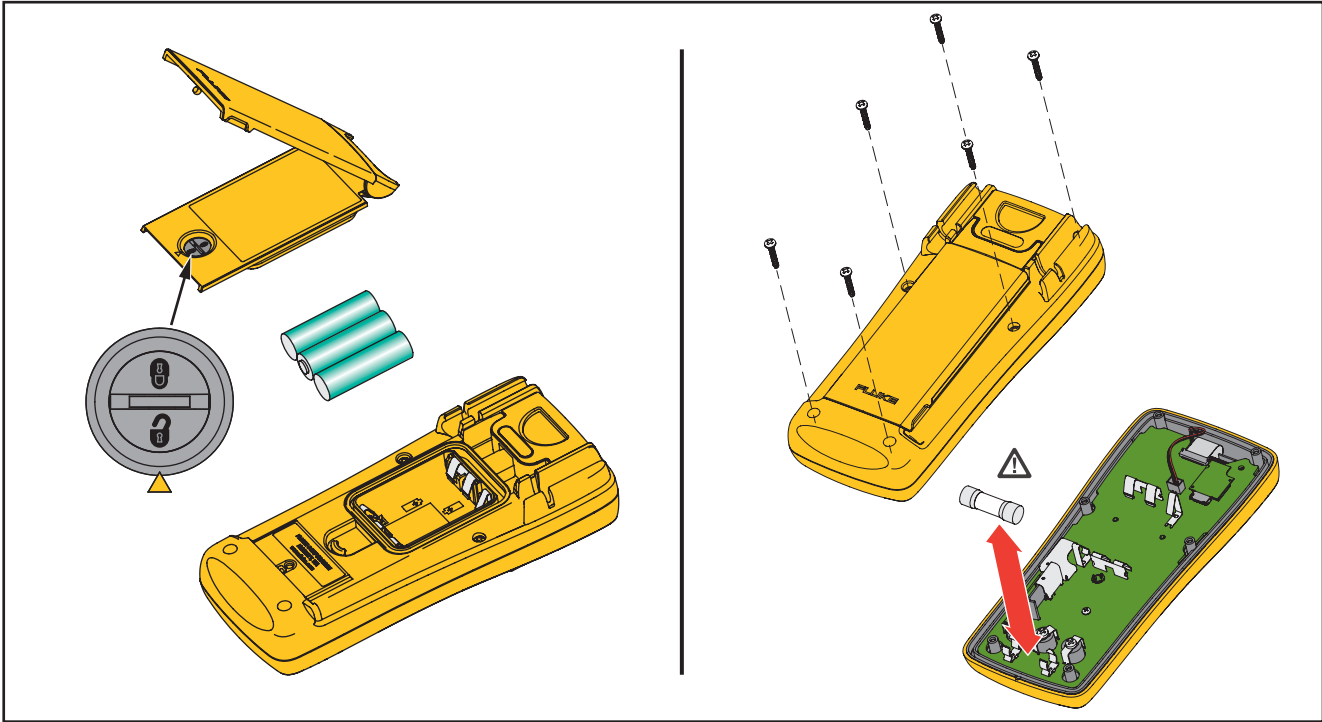

gxr010.eps

Figure 11. Battery and Fuse Replacement



Service and Parts

If the Product fails, replace the batteries and do a fuse test. Read this manual to make sure the Product is applied correctly.

Replacement parts and accessories are shown in Table 6 and Figure 12.

To get parts and accessories, refer to the “How to Contact Fluke” section.

Table 6. Replaceable Parts

Description	Qty.	Fluke Part or Model Number
 Fuse, 440 mA, 1000 V	1	943121
Battery, AA 1.5 V	3	376756
Battery Door Assembly (includes tilt stand)	1	4207624
Gasket, Battery Door	1	4137532
Test Lead Set	1	TL175
Alligator Clip, Black	1	AC175
Alligator Clip, Red	1	
CNX 3000 DMM Quick Reference Guide	1	4231002
CNX 3000 DMM Safety Information	1	4231677
 To ensure safety, use exact replacement only.		

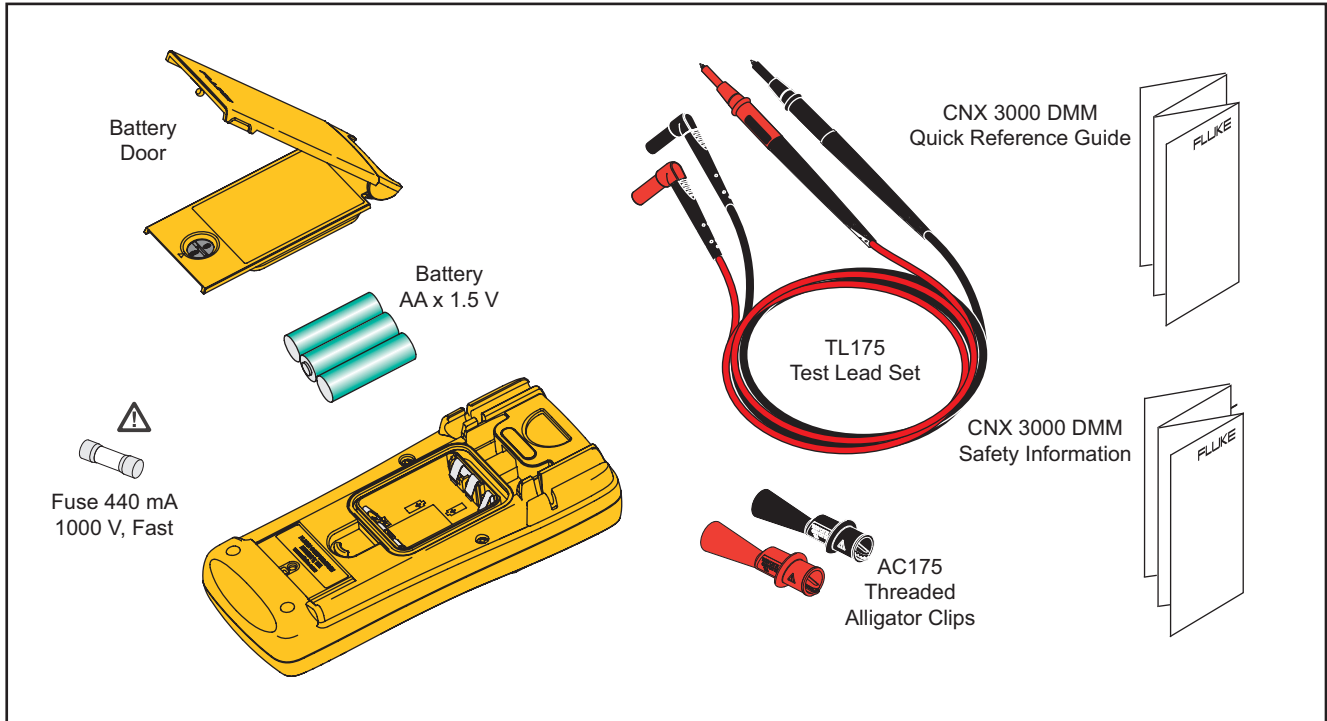

Figure 12. Replacement Parts

gxr012.eps

Table 7. Accessories

Item	Description
TPAK	ToolPak Magnetic Hanger
FLK-CNX A3000	CNX a3000 Clamp Module – Measure ac current to 400 amps,
FLK-CNX I3000	CNX i3000 Flex Current – Measures ac current to 2500 amps.
FLK-CNX T3000	CNX t3000 Temperature Module – Measures temperature with a k-type thermocouple from -200 °C to 1372 °C
FLK-CNX V3000	CNX v3000 Voltage Module – Measures ac voltage to 1000 V ac.
FLK-CNX PC3000	CNX pc3000 Wireless PC Adapter
FLK-CNX C3000	Deluxe tool bag with shoulder strap.
FLK-CNX C3001	Modular module case.
FLK-CNX C3002	Modular DMM Case
FLK-CNX C3003	Modular 3-compartment case.

Specifications

Maximum voltage between any Terminal and Earth Ground: 1000 V dc or ac rms

⚠ Fuse Protection for mA inputs0.44 A (44/100 A, 440 mA), 1000 V FAST Fuse, Fluke specified part only

Display (LCD)

Update rate4/sec

Volts, amps, ohms,..... 6000 counts

Frequency10,000 counts

Capacitance1,000 counts

Battery Type.....Three AA Alkaline batteries, NEDA 15A IEC LR6

Battery Life.....250 hours minimum

Temperature

Operating-10 °C to 50 °C

Storage.....-40 °C to 60 °C

Relative Humidity0 % to 90 % (0 °C to 35 °C), 0 % to 75 % (35 °C to 40 °C), 0 % to 45 % (40 °C to 50 °C)

Altitude

Operating2,000 m

Storage.....12,000 m

Temperature Coefficient.....0.1 X (specified accuracy) /°C (<18 °C or >28 °C)

Safety Standards

US ANSI.....ANSI/ISA 61010-1 / (82.02.01): 3rd edition

CSA.....CAN/CSA-C22.2 No 61010-1-12: 3rd edition

UL.....UL 61010-1: 3rd edition

CE European.....IEC/EN 61010-1:2010

CNX 3000

Users Manual

Wireless Frequency	2.4 GHz ISM Band 20 meter range
Size (HxWxL)	1.87 in x 3.68 in x 8.14 in (4.75 cm x 9.3 cm x 20.7 cm)
Weight	17.2 oz (487.5 g)
EMI, RFI, EMC, RF	EN 61326-1:2006, EN 61326-2-2:2006, ETSI EN 300 328 V1.7.1:2006, ETSI EN 300 489 V1.8.1:2008, FCC Part 15 Subpart C Sections 15.207, 15.209, 15.249, FCCID : T68-FWCS IC:6627A-FWCS

Detailed Specifications

For all specifications:

Accuracy is specified for 1 year after calibration, at operating temperatures of 18 °C to 28 °C, with relative humidity at 0 % to 90 %. Accuracy specifications take the form of \pm [% of Reading] + [Number of least significant digits]).

AC Voltage

Range ^[1]	Resolution	Accuracy ^{[2][3][4]}	
		45 Hz to 500 Hz	500 Hz to 1 kHz
600.0 mV	0.1 mV	1.0 % + 3	2.0 % + 3
6.000 V	0.001 V		
60.00 V	0.01 V		
600.0 V	0.1 V		
1000 V	1 V		

- [1] All ac voltage ranges are specified from 1 % of range to 100 % of range.
- [2] Crest factor of ≤ 3 at 4000 counts, decreasing linearly to 1.5 at full scale.
- [3] For non-sinusoidal waveforms, add $-(2\% \text{ of reading} + 2\% \text{ full scale})$ typical, for crest factor up to 3.
- [4] Do not exceed 10^7 V-Hz

DC Voltage, Continuity, Resistance, Diode Test, and Capacitance

Function	Range	Resolution	Accuracy
$\overline{\text{mV}}$	600.0 mV	0.1 mV	0.09 % + 2
$\overline{\text{V}}$	6.000 V	0.001 V	0.09 % + 2
	60.00 V	0.01 V	
	600.0 V	0.1 V	
	1000 V	1 V	0.15 % + 2
 	600 Ω	1 Ω	Meter beeps at <25 Ω , beeper detects opens or shorts of 250 μs or longer.
Ω	600.0 Ω	0.1 Ω	0.5 % + 2
	6.000 k Ω	0.001 k Ω	0.5 % + 1
	60.00 k Ω	0.01 k Ω	
	60.00 k Ω	0.1 k Ω	
	600.0 k Ω	0.001 M Ω	
	50.00 M Ω	0.01 M Ω	1.5 % + 3
Diode Test	2.000 V	0.001 V	1 % + 2
⎓	1000 nF	1 nF	1.2 % + 2
	10.00 μF	0.01 μF	
	100.0 μF	0.1 μF	
	9999 μF ^[1]	1 μF	10 % typical

[1] In the 9999 μF range for measurements to 1000 μF , the measurement accuracy is 1.2 % + 2.

AC and DC Current

Function	Range ^[1]	Resolution	Accuracy
$\tilde{\text{mA}}$ (45 Hz to 1 kHz)	60.00 mA	0.01 mA	1.5 % + 3
	400.0 mA ^[3]	0.1 mA	
mA_{DC} ^[2]	60.00 mA	0.01 mA	0.5 % + 3
	400.0 mA ^[3]	0.1 mA	

[1] All ac current ranges are specified from 5 % of range to 100 % of range.
 [2] Input burden voltage (typical): 400 mA input 2 mV/mA.
 [3] 400.0 mA accuracy specified up to 600 mA overload.

Frequency

Range	Resolution	Accuracy ^[1]
99.99 Hz	0.01 Hz	0.1 % + 1
999.9 Hz	0.1 Hz	
9.999 kHz	0.001 kHz	
99.99 kHz	0.01 kHz	

[1] Frequency is specified up to 99.99 kHz in volts and up to 10 kHz in amps.

Frequency Counter Sensitivity

Input Range ^{[1][2]}		Typical Sensitivity (RMS Sine Wave)				
		2 Hz to 45 Hz	45 Hz to 10 kHz	10 kHz to 20 kHz	20 kHz to 50 kHz	50 kHz to 100 kHz
\tilde{V}	6 V	0.5 V	0.6 V	1.0 V	2.8 V	Unspecified ^[3]
	60 V	5 V	3.8 V	4.1 V	5.6 V	9.6 V
	600 V	50 V	36 V	39 V	50 V	58 V
	1000 V	500 V	300 V	320 V	380 V	NA
$\overline{\tilde{V}}$	6 V	0.5 V	0.75 V	1.4 V	4.0 V	Unspecified ^[3]
	60 V	4 V	3.8 V	4.3 V	6.6 V	13 V
	600 V	40 V	36 V	39 V	45 V	58 V
	1000 V	500 V	300 V	320 V	380 V	NA
\tilde{mA}	60.00 mA	5 mA	4 mA	NA	NA	NA
	400.0 mA	5 mA	4 mA	NA	NA	NA

[1] Maximum input for specified accuracy = 10X Range or 1000 V.
 [2] Noise at low frequency and amplitude may exceed the frequency accuracy specification.
 [3] Unspecified but usable depending on quality and amplitude of signal.
 [4] In mA and A ranges, frequency measurement is specified to 10 kHz.

Input Characteristics

Function	Overload Protection	Input Impedance (nominal)	Common Mode Rejection Ratio (1 k Ω unbalance)		Normal Mode Rejection
$\overline{\text{V}}$	1100 V rms	>10 M Ω <100 pF	> 120 dB at dc, 50 Hz or 60 Hz		> 60 dB at 50 Hz or 60 Hz
V	1100 V rms	>10 M Ω < 100 pF	> 60 dB, dc to 60 Hz		
mV	1100 V rms	>10 M Ω <100 pF	> 120 dB at dc, 50 Hz or 60 Hz		> 60 dB at 50 Hz or 60 Hz
		Open Circuit Test Voltage	Full Scale Voltage		Typical Short Circuit Current
			To 6 M Ω	50 M Ω	
Ω / Hz	1100 V rms	<2.7 V dc	<0.7 V dc	<0.9 V dc	<350 μ A
mV / Hz	1100 V rms	<2.7 V dc	2.000 V dc		<1.1 mA
Function	Overload Protection		Overload		
mA	Fused, 44/100 A, 1000 V FAST Fuse		600 mA overload for 2 minutes maximum, 10 minutes rest minimum		

MIN MAX Recording

Function	Accuracy
DC Functions	The specified accuracy of the measurement function ± 12 counts for changes >350 ms in duration.
AC Functions	The specified accuracy of the measurement function ± 40 counts for changes >900 ms in duration.