

## Advanced Thermal Imaging Camera

G9700 Series - G9706

The thermographic handheld camera is based on the thermal technology, specially designed for the needs of temperature measuring applications. People can quickly troubleshoot faults on-site.



- Thermal resolution: 640 x 512 (327 680 pixels)
- NETD: < 35 mK (@ 25 °C, F#=1.0)
- Temperature measurement range: -20 °C to 650 °C (-4 °F to 1202 °F)
- Accuracy: Max ( $\pm 2$  °C/3.6 °F,  $\pm 2\%$ )
- Measurement presets: Center spot, Hot spot, Cold spot, User Preset Point/Line/Area
- Auto/Manual/Laser focus
- 50 Hz image frequency
- 4.3" LCD touch screen display
- 8 MP optical camera
- Up to 4 hours continuous running

### Dimensions

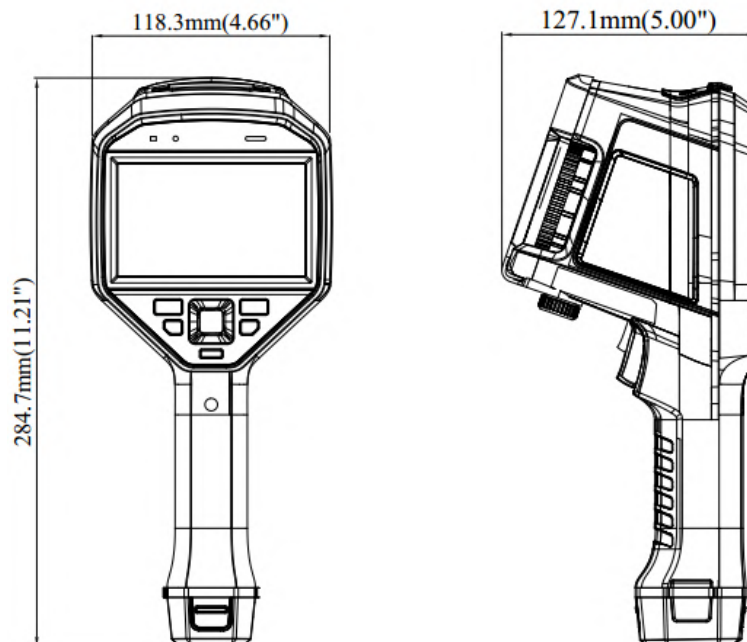

Specifications		Best Accuracy
Thermal Module	Image Sensor	Vanadium Oxide Uncooled Focal Plane Arrays
	IR Resolution	640 x 512 (327 680 pixels)
	Pixel Pitch	17µm
	Spectral Range	8µm to 14µm
	NETD	< 35 mK (@ 25 °C, F#=1.0)
	Focal Length	25 mm
	Field of View	25° × 19°
	Image Frequency	50 Hz
	Focus	Continuous Autofocus/Autofocus/Manual Focus/Laser Assisted Focus
	IFOV (Spatial Resolution)	0.68 mrad
	Aperture	F1.1
	Minimum Focus Distance	0.3 m (0.98 ft)
Optical Module	Picture Resolution	Configurable: 2 MP, 5 MP, 8 MP
	Video Resolution	640 x 480
	Focus	Fixed
	FOV	25° × 19°
Image Display	Display	800 x 480 resolution, 4.3" LCD touch screen
	Color Palettes	Black hot, White hot, Red hot, Rainbow, Ironbow, Fusion, Rain
	Digital Zoom	Thermal: 1x, 2x, 4x, 8x
	Image Modes	Thermal/Optical/Fusion image/Picture in Picture
	Picture in Picture	Thermal Picture in Optical Picture
	Fusion	Thermal Picture and Optical Picture Combined
Measurement and Analysis	Object Temperature Range	20 °C to 650 °C (4 °F to 1202 °F)
	Accuracy	Max (±2°C/3.6°F, ±2%)
	Measurement Presets	Center Spot, Hot Spot, Cold Spot, Off
	Point	10 User Presets
	Line	1 User Presets
	Area	3 User Presets
	High Temperature Alarm	Audible Warning
Storage	Color Alarn (Isotherm)	Above/Below/Interval/Insulation
	Storage Media	Removable Micro SD Card (64 GB)
	Image Storage Capacity	60,000 Images
	Image File Format	JPEG with Measurement Data Included
	Video Storage Capacity	54 Hours

## Packing List

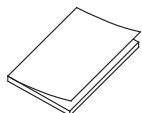

Quick Start Guide (x1)



Type-C Cable (x1)



Hand Strap (x1)



CVBS Cable (x1)

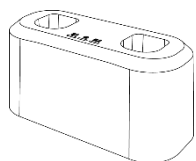

Charging Base (x1)

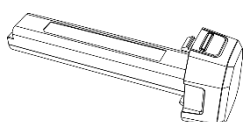

Battery (x2)

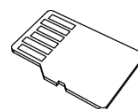

Micro SD Card (x1)

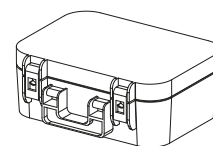

Box (x1)

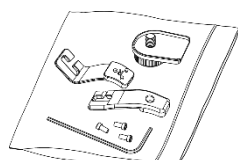

Tools Package (x1)

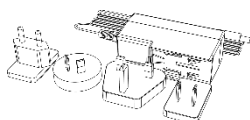

Charger (x1)

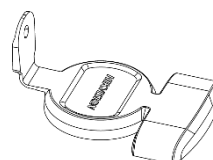

Lens Cover (x1)

## Optional



Teleconverter 0.5x



Teleconverter 2x

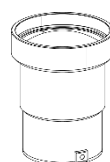

Teleconverter 3.3x