

Rosemount™ 56

Advanced Dual-Input Analyzer



Essential Instructions

Read this page before proceeding

Your instrument purchase from Emerson is one of the finest available for your particular application. These instruments have been designed, and tested to meet many national and international standards. Experience indicates that its performance is directly related to the quality of the installation and knowledge of the user in operating and maintaining the instrument. To ensure their continued operation to the design specifications, personnel should read this manual thoroughly before proceeding with installation, commissioning, operation, and maintenance of this instrument. If this equipment is used in a manner not specified by the manufacturer, the protection provided by it against hazards may be impaired.

- Failure to follow the proper instructions may cause any one of the following situations to occur: Loss of life; personal injury; property damage; damage to this instrument; and warranty invalidation.
- Ensure that you have received the correct model and options from your purchase order. Verify that this manual covers your model and options. If not, call 1-800-854-8257 or 949-757-8500 to request correct manual.
- For clarification of instructions, contact your Rosemount representative.
- Follow all warnings, cautions, and instructions marked on and supplied with the product.
- Use only qualified personnel to install, operate, update, program and maintain the product.
- Educate your personnel in the proper installation, operation, and maintenance of the product.
- Install equipment as specified in the Installation section of this manual. Follow appropriate local and national codes. Only connect the product to electrical sources specified in this manual.
- Use only factory documented components for repair. Tampering or unauthorized substitution of parts and procedures can affect the performance and cause unsafe operation of your process.
- All instrument enclosures must be closed and protective covers must be in place unless qualified personnel are performing maintenance.

WARNING



RISK OF ELECTRICAL SHOCK

Equipment protected throughout by double insulation.

- Installation and servicing of this product may expose personnel to dangerous voltages.
 - Main power wired to separate power source must be disconnected before servicing.
 - Do not operate or energize instrument with case open!
 - Signal wiring connected in this box must be rated at least 240 V for European mains operation.
 - Non-metallic cable strain reliefs do not provide grounding between conduit connections! Use grounding type bushings and jumper wires.
 - Unused cable conduit entries must be securely sealed by non-flammable closures to provide enclosure integrity in compliance with personal safety and environmental protection requirements. Unused conduit openings must be sealed with Type 4X or IP66 conduit plugs to maintain the ingress protection rating (Type 4X)
 - Electrical installation must be in accordance with the National Electrical Code (ANSI/NFPA-70) and/or any other applicable national or local codes.
 - Operate only with front panel fastened and in place.
 - Safety and performance require that this instrument be connected and properly grounded through a three-wire power source.
 - Proper use and configuration is the responsibility of the user.
-

CAUTION

This product generates, uses, and can radiate radio frequency energy and thus can cause radio communication interference. Improper installation, or operation, may increase such interference. As temporarily permitted by regulation, this unit has not been tested for compliance within the limits of Class A computing devices, pursuant to Subpart J of Part 15, of FCC Rules, which are designed to provide reasonable protection against such interference. Operation of this equipment in a residential area may cause interference, in which case the user at his own expense, will be required to take whatever measures may be required to correct the interference.

WARNING

Physical access

Unauthorized personnel may potentially cause significant damage to and/or misconfiguration of end users' equipment. This could be intentional or unintentional and needs to be protected against.

Physical security is an important part of any security program and fundamental to protecting your system. Restrict physical access by unauthorized personnel to protect end users' assets. This is true for all systems used within the facility.

Section i: Quick Start Guide

1. Refer to Section 2.0 for mechanical installation instructions.
2. Wire sensor(s) to the signal boards. See Section 3.0 for wiring instructions. Refer to the sensor instruction sheet for additional details. Make current output, alarm relay and power connections
3. Once connections are secured and verified, apply power to the analyzer.

WARNING



RISK OF ELECTRICAL SHOCK

Electrical installation must be in accordance with the National Electrical Code (ANSI/NFPA-70) and/or any other applicable national or local codes.



CAUTION: This symbol identifies a risk of electrical shock.



CAUTION: This symbol identifies a potential hazard. When this symbol appears, consult the manual for appropriate action.

4. When the analyzer is powered up for the first time, Time/Date and Quick Start screens appear. Quick Start operating tips are as follows:
 - a. Window screens will appear. The field with the focus will appear with dark blue back-lighting. The field with focus can be edited by press ENTER/MENU.
 - b. The Time and Date screen to set the real-time clock will appear. Accept the displayed time by pressing ENTER on Time and date OK or press the down key to Change the time and date.
 - c. The first Quick Start screen appears. Choose the desired language by pressing ENTER/MENU to edit the active field and scrolling to the language of choice. Press ENTER/MENU and press the down arrow to highlight NEXT.
 - d. The Navigation Rules for operating the keypad will be displayed.
 - e. Choose the measurement for Sensor 1 (and Sensor 2) and proceed to the remaining Quick Start steps.
 - f. Keypad operation guidelines will appear to guide the user how operate the user interface.
 - g. NOTE: To edit a field with backlit focus, press ENTER/MENU. To scroll up or down, use the keys to above or below the ENTER key. To move the cursor left or right, use the keys to the left or right of the ENTER key. To edit a numeric value including decimal points, use the alphanumeric keypad then press ENTER.
 - h. NOTE: Press ENTER to store a setting or value. Press EXIT to leave without storing changes. Pressing EXIT during Quick Start returns the display to the initial start-up screen (select language). To proceed to the next Quick Start step, use the right key or the down key to highlight NEXT. Press ENTER.
5. After the last step, the main display appears. The current outputs are assigned to default values before probes are wired to the analyzer. After the last step, the main display appears. The outputs are assigned to default values.
6. To change output, and all settings, press ENTER/MENU from the live screen. Using the down and right arrow keys, select one of the following menus and navigate the screen of choice.
7. To return the analyzer to the default settings, choose Reset under the Menu selection screen.

SAFETY MESSAGES

Procedures and instructions in this section may require special precautions to ensure the safety of the personnel performing the operations. Information that raises potential safety issues is indicated by a warning symbol (). The symbol identifies a potential hazard.

Contents

Section 1: Description and Specifications

1.1 Features and Applications.....	1
1.2 Enhanced Features	2
1.3 Specifications-General	3
1.4 Contacting Conductivity	6
1.5 Toroidal Conductivity	7
1.6 pH/ORP	8
1.7 Flow	9
1.8 4-20 mA Current Input.....	9
1.9 Chlorine.....	10
1.10 Dissolved Oxygen	12
1.11 Dissolved Ozone.....	12
1.12 Turbidity.....	13
1.13 Ordering Information	14

Section 2: Installation

2.1 Unpacking and Inspection	15
2.2 Installation	15

Section: 3 Wiring

3.1 General	21
3.2 Preparing Conduit Openings	22
3.3 Preparing Sensor Cable.....	22
3.4 Power, Output, Alarms and Sensor Connections.....	22

Section 4: Display and Operation

4.1 User Interface	31
4.2 Instrument Keypad.....	31
4.3 Main Display	31
4.4 Menu System.....	32
4.5 USB Data Port.....	33
4.6 56 Data Logger and Event Logger Download Procedure	33
4.7 Software Upgrade	35
4.8 Configuration Transfer	35

Section 5: Programming the Analyzer - Basics

5.1 General	37
5.2 Changing the Startup Settings	37
5.3 Programming Temperature	38
5.4 Configuring and Ranging the Current Outputs	38
5.5 Setting a Security Code	39
5.6 Security Access.....	39
5.7 Using Hold	40
5.8 Resetting Factory Defaults – Reset Analyzer	40
5.9 Programming Alarm Relays.	40

Section 6: Programming - Measurements

6.1 Programming Measurements – Introduction	43
6.2 pH	43
6.3 ORP	44
6.4 Contacting Conductivity.....	45
6.5 Toroidal Conductivity	46
6.6 Chlorine.....	47
6.7 Dissolved Oxygen	50
6.8 Dissolved Ozone	51
6.9 Turbidity	51
6.10 Flow	52
6.11 Current Input	52

Section 7: PID Control

7.1 Introduction	55
7.2 PID Setup.....	59

Section 8: Time Proportional Control

8.1 Introduction	63
8.2 TPC Setup.....	63

Section 9: Alarm Relay Functions

9.1 General.....	67
9.2 High/Low Concentration Alarm	67
9.3 Delay Timer:	68
9.4 Bleed and Feed	70
9.5 Totalizer Based Relay Activation	71
9.6 Interval Timer	72
9.7 Date and Time Activation	74

Section 10: Calibration

10.1 Calibration – Introduction	75
10.2 pH Calibration	75
10.3 ORP Calibration	76
10.4 Contacting Conductivity Calibration	77
10.5 Toroidal Conductivity Calibration	79
10.6 Chlorine Calibration	80
10.7 Oxygen Calibration	82
10.8 Ozone Calibration	84
10.9 Calibrating Temperature	85
10.10 Turbidity	85
10.11 Pulse Flow	86

Section 11: HART® Communications

11.1 Introduction	87
11.2 Physical Installation and Configuration	88
11.3 Measurements Available via HART	89
11.4 Diagnostics Available via HART	90
11.5 HART Hosts	91
11.6 Wireless Communication using the 56.....	94
11.7 Field Device Specification (FDS).....	94

Section 12: Profibus Communications

12.1 General	95
12.2 Profibus Features	95
12.3 Profibus Communications	96
12.4 Data Transmission	100
12.5 Installation and Wiring.....	111

Section 13: Maintenance

13.1 Overview	113
13.2 Analyzer Maintenance	113
13.3 USB Port	113

Section 14: Return of Material

14.1 General.....	115
14.2 Warranty Repair	115
14.3 Non-Warranty Repair	115

HART Appendix 1	117
-----------------------	-----

HART Appendix 2	121
-----------------------	-----

Section 1: Description and Specifications

1.1 Features and Applications

This multi-parameter unit serves industrial, commercial and municipal applications with the widest range of liquid measurement inputs and digital communications available.

The 56 advanced dual-input analyzer supports continuous measurement of liquid analytical inputs from one or two sensors. The modular design allows signal input boards to be field replaced, making configuration changes easy. The high resolution full-color display gives unsurpassed visibility and functionality for liquid analytical instrumentation.

Dual Input Instrument: single or dual measurement of pH/ORP, Resistivity/ Conductivity, % Concentration, Total Dissolved Solids, Total Chlorine, Free Chlorine, Monochloramine, Dissolved Oxygen, Dissolved Ozone, Turbidity, Pulse Flow, Temperature, and 4-20 mA input from any device.

Full Color Display: The high resolution full-color display allows at-a-glance viewing of process readings – indoors or outdoors. Six additional process variables or diagnostic parameters are displayed for quick determination of process or sensor condition. The contrast of back-lit display can be adjusted and the main screen can be customized to meet user requirements.

Digital Communications: HART® version 5 and 7 digital communications are available on the 56. An optional Profibus® DP digital communications board is available for Profibus installations. 56 HART units communicate with the 475 HART hand-held communicator and HART hosts such as AMS Intelligent Device Manager. 56 Profibus units are fully compatible with Profibus DP networks and Class 1 or Class 2 masters. HART and Profibus DP configured units will support any single or dual measurement configurations of the 56.

Menus: Easily-managed window screens for easy navigation to local configuration and routine calibration. Quick Start and all menu screens are available in multiple locally displayed languages. Alpha-numeric keypad allows easy entries during configuration and calibration.

Quick Start Programming: Popular Quick Start screens appear the first time the unit is powered. The instrument auto-recognizes each measurement input type and prompts the user to configure each sensor loop in a few quick steps for immediate commissioning.

User Help Screens: A complete user guide and troubleshooting manual is embedded in the instrument's memory and easily accessed via the INFO key on the local display. Detailed instructions and troubleshooting tips in multiple languages are intended to provide adequate guidance to resolve most problems on site.

Hazardous Area Approvals and Safety Approvals: None.

Enclosure: The instrument enclosure fits standard ½ DIN panel cutouts. The versatile enclosure design supports panel-mount, pipe-mount, and surface/wall-mount installations. No Enclosure ratings – None.

Security Access Codes: Two levels of security access are available. Program one access code for routine maintenance and hold of current outputs; program another access code for all configuration menus and functions.

Diagnostics: The analyzer continuously monitors itself and the sensor(s) for fault and warning

conditions. A display banner flashes red to indicate a Fault condition and yellow for a Warning condition to visually alert field personnel. Details and troubleshooting information for any specific fault or warning can be readily accessed by pressing the INFO key.

Local Languages: Rosemount extends its worldwide reach by offering nine menu languages – English, French, German, Italian, Spanish, Portuguese, Chinese, Russian and Polish. Every unit includes user programming menus; calibration routines; faults and warnings; and user help screens in all nine languages.

Current Outputs: Every unit includes four 4-20 mA or 0-20 mA electrically isolated current outputs giving the ability to transmit the measurement value and the temperature for both sensors. Users have wide latitude to assign any measurement value or live diagnostic to any current output for reporting. Output dampening can be enabled with time constants from 0 to 999 seconds. HART digital communications transmitted via current output 1 is standard on all units (option code HT).

1.2 Enhanced Features

Process Trending Graphs: High-resolution color graphs of measurement data can be displayed on-screen to pinpoint process disruptions or measurement problems and to estimate probe maintenance frequency. The analyzer gives the user the ability to zoom in to a specific narrow timeframe of process measurements for detailed on-screen evaluation.

Data Logger and Event Logger: Extensive onboard data storage captures measurement data from both channels every 30 seconds for 30 days for on-screen display or local upload to a USB 2.0 memory device. 300 significant analyzer events are recorded including start-up time, calibrations, hold outputs, configurations, alarms, power interruptions, faults, and more. All process data and events are time/date stamped.

USB 2.0 Data Transfer Port: A USB port is built-in to allow local data transfer of process data and events using a standard USB memory device. Cleanly formatted EXCEL data is useful for evaluation of process data on a computer and identification of critical alarm or fault events.

PID Control: Proportional, Integral and Derivative settings allow the analog current outputs to adjust a control device that has continuous adjustability by acting on process measurements or temperature. PID is typically used on modulating control devices such as automated control valves or variable volume pumps. Any current output can be programmed for PID functions.

Alarm Relay Capabilities: Four Single Pole Double Throw alarm relays are fully assignable and programmable to trigger alarms upon reaching measurement or diagnostics setpoints or fault conditions. Further relay settings include TPC, synchronized interval timers and four specialized timer functions described below. All relays are independently activated. Failsafe operation and programming of relay default state (normally open or normally closed) is software selectable.

Timer Functions: Basic TPC (Time Proportional Control) settings are available. Interval timers set relays by interval time, on-time and recovery time for discrete on/off control devices based on measurement inputs. In addition, four real-time clock relay functions are implemented including: bleed and feed, day and time interval timers, delay timer and a flow totalizer. These advanced timer features support a number of specialized applications that normally require dedicated timer control devices or DCS programming.

Wireless Thum Adaptor Compatible: Enable wireless transmissions of process variables and diagnostics from hard-to-reach locations where it is impractical to run wires for current outputs. When commissioned with the THUM Adaptor, 56 HART® units can communicate on Emerson wireless networks using HART 7 wireless protocol.

Smart-Enabled pH: Rosemount SMART pH capability can eliminate field calibration of pH probes through automatic upload of calibration data and history – fully calibrating the pH loop. pH probe changes are literally plug and play using SMART pH sensors with VP cables connections.

Advanced Functions: Several specialty measurements are supported including: high reference impedance pH sensors, Ion Selective Electrode measurements, pH loop calibration by entering pH slope and reference offset, Isopotential point for pH, inferred pH determination using dual contacting conductivity inputs, differential conductivity, differential flow, totalized flow, current input from any 4-20 mA source, dual range calibration for chlorine sensors, programmable polarizing voltage for amperometric oxygen sensors and software selectable normally open or normally closed alarm relays – to name a few.

1.3 Specifications - General

Case: Polycarbonate. Type 4X, IP66.

NOTE:

To ensure a water-tight seal, tighten all four front panel screws to 6 in-lbs of torque.

Dimensions: 6.2 x 6.2 x 5.2 in. (157 x 157 x 132 mm)

Conduit openings: Accepts (6) PG13.5 or 1/2 in. conduit fittings

Display: Large 3.75 x 2.2 in. (95.3 x 55.9mm) high resolution color LCD displays large process variables and user-definable display of diagnostic parameters. Calibration, programming and information screens display clear, easy-to-read characters. The color display is back-lit and backlighting intensity is user adjustable. Measurement character height: (.5") 13mm. Main display can be customized to meet user requirements.

Ambient temperature and humidity: -10 to 60 °C, (14 to 140 °F) RH 5 to 95% (non-condensing). For Turbidity only: 0 to 55 °C (32 to 131 °F). RH 5 to 95% (non-condensing).

NOTE:

The analyzer is operable from -5 to 55 °C (-23 to 131 °F) with some degradation in display response or performance. Above 60 °C, the following components will progressively and automatically shut down: display, USB communications port, current outputs, alarm relays, main circuit board.

WARNING

Always remove USB memory device at ambient temp above 60 °C. Do not access USB port if combustible atmosphere is present.

Storage temperature: -20 to 60 °C, (-4 to 140 °F)

Power: Code -02: 20 to 30 VDC, 20 W
Code -03: 85 to 264 VAC, 47.5 to 65.0 Hz, 20 W

Real time clock back-up: 24 hours.

Hazardous Location Approvals:

Options for CSA: 02, 03, 20, 21, 22, 24, 25, 26, 27, 30, 31, 32, 34, 35, 36, 37, 38, HT and DP



-LR 34186
Class I, Division 2, Groups A, B, C, & D
Class II, Division 2, Groups E, F, & G
Class III
T4 Tamb = 60 °C
Enclosure Type 4X, IP66

See Non-Incendive Field Wiring drawing 1400668. The 'C' and 'US' indicators adjacent to the CSA Mark signify that the product has been evaluated to the applicable CSA and ANSI/UL Standards, for use in Canada and the U.S. respectively. Evaluated to CSA Standards: 22.2 Numbers: 1-10. 0.4-04, 25-1996, 94-M1991, 142-M1987, 213-M1987, 60529:05. ANSI/IEC 60529:04. ANSI/ISA:12.12.01:2007. UL No. 50:11th Ed. and No. 508:17th Ed.

Note: Single-input Turbidity configurations (models 56-02-27-38 or -HT, 56-03-27-38 or -HT) and dual-input Turbidity only configurations (56-02-27-37 or -HT, 56-03-27-37 -HT) are CSA approved class I Div. 2 for hazardous area installation.

Options for FM: -02, 03, 20, 21, 22, 23, 24, 25, 26, 27, 30, 31, 32, 33, 34, 35, 36, 37, 38, HT and DP.



Class I, Division 2, Groups A, B, C, & D
Class II & III, Division 2, Groups E, F, & G
T4 -10 °C ≤ Tamb ≤ 60 °C
IP66

See Non-Incendive Field Wiring drawing 1400667.
Evaluated to FM Standards: 3600:2011, 3611:2004, 3810:2005, ANSI/IEC: 60529:2004.

Note: Single-input Turbidity configurations (models 56-02-27-38 or -HT, 56-03-27-38 or -HT) and dual-input Turbidity only configurations (56-02-27-37 or -HT, 56-03-27-37 or -HT) are FM approved class I Div. 2 for hazardous area installation.

Ordinary Locations (only with - UL ordering option):



Options for UL: -02, 03, 20, 21, 22, 24, 25, 26, 27, 30, 31, 32, 34, 35, 36, 37, 38, HT and DP.

Pollution Degree 2: Normally only non-conductive pollution occurs. Occasionally, however, a temporary conductivity caused by condensation must be expected.

Altitude: for use up to 2000 meter (6562 ft.)

EMI/RFI Effect

Meets all industrial requirements of EN 61326.

HART Analog and Digital Communication

No effect on the values being given if using 4-20 mA analog or HART digital signal with shielded, twisted pair wiring.

Profibus DP Digital Communication

No effect on the values being given if using Profibus DP digital signal.

Note 1

During EMI disturbance, the maximum sensor deviation is ±0.004 ppm (4 ppb) for options 24, 25, 26, 34, 35, and 36.

LVD: EN-61010-1:2010 

Input: One or two isolated sensor inputs. Measurement choices of pH/ORP, resistivity/conductivity/ TDS, % concentration, ratio conductivity, total and free chlorine, monochloramine, dissolved oxygen, dissolved ozone, turbidity, pulse flow, temperature and raw 4-20 mA input. For contacting conductivity measurements, temperature element can be a Pt100 RTD or Pt1000 RTD. For other measurements (except ORP, flow and turbidity), use either a PT100 RTD, PT1000 RTD, or 22k NTC (D.O. only).

Outputs: Four 4-20 mA or 0-20 mA isolated current outputs. Fully scalable. Max Load: 550 Ohms. Output 1 superimposes the HART® digital signal. Outputs can be programmed for PID control. Output dampening can be enabled with time constants from 0 to 999 seconds. HART digital communications transmitted via current output 1 is standard on all units (option code HT).

Alarms: Four alarm relays for process measurement(s) or temperature. Any relay can be programmed for any measurement, timer, TPC or fault alarm operation, instead of a process alarm. When selected, a fault alarm will activate the relay when a sensor or analyzer fault occurs. Each relay can be configured independently. Alarm logic (high or low activation or USP*) and deadband are user-programmable.

*USP alarm can be programmed to activate when the conductivity is within a user-selectable percentage of the limit. conductivity/resistivity measurement only)

Maximum Relay Current	
Power Input	Resistive
28 VDC 5.0 A	5.0 A
115 VAC 5.0 A	5.0 A
230 VAC 5.0 A	5.0 A

Relays: Form C, SPDT, epoxy sealed

Inductive load: 1/8 HP motor (max.), 115/240 VAC

Terminal Connections Rating:

Power connector (02 order code, 24 VDC power supply and 03 order code, 85-264 VAC power supply): 24-12 AWG wire size.

Signal board terminal blocks: 26-16 AWG wire size.

Current output connectors: 26-16 AWG wire size.

Alarm relay terminal blocks: 24-12 AWG wire size.

Weight/Shipping Weight: (rounded up to nearest lb or nearest 0.5 kg): 3 lbs/4 lbs (1.5 kg/2.0 kg)

1.4 Contacting Conductivity (Codes -20 and -30)

Measures conductivity in the range 0 to 600,000 $\mu\text{S}/\text{cm}$ (600 mS/cm). Measurement choices are conductivity, resistivity, total dissolved solids, salinity, and % concentration. Temperature compensation can be disabled, allowing the analyzer to display raw conductivity.

NOTE:

When two contacting conductivity sensors are used, The 56 can derive an inferred pH value. Inferred pH is calculated pH, not directly measured pH. Inferred pH is calculated from straight and cation conductivity. It is applicable only if the alkalinizing agent is NaOH or NH_3 and the major contaminant is NaCl. It is strictly an application for power plants.

Performance Specifications - Analyzer

Measurement Range: see table below

Solution temperature compensation: manual slope ($X\% / ^\circ\text{C}$), high purity water (dilute sodium chloride), and cation conductivity (dilute hydrochloric acid).

Salinity: uses Practical Salinity Scale

Total Dissolved Solids: Calculated by multiplying conductivity at 25°C by 0.65

Five percent concentration curves: 0-12% NaOH, 0-15% HCl, 0-20% NaCl, 0-25% or 96-99.7% H_2SO_4 . The conductivity concentration algorithms for these solutions are fully temperature compensated.

Four temperature compensation options: manual slope ($X\% / ^\circ\text{C}$), high purity water (neutral salt), cation conductivity (dilute hydrochloric acid) and raw.

Input filter: time constant 1 - 999 sec, default 2 sec.

Response time: 3 seconds to 95% of final reading

Recommended Sensors for Contacting Conductivity:

All Rosemount ENDURANCE 400 series conductivity sensors (Pt 1000 RTD) and 410VP 4-electrode high-range conductivity sensor.

PERFORMANCE SPECIFICATIONS

Recommended Range – Contacting Conductivity

Cell Constant	0.01 S/cm	0.1 $\mu\text{S}/\text{cm}$	1.0 $\mu\text{S}/\text{cm}$	10 $\mu\text{S}/\text{cm}$	100 $\mu\text{S}/\text{cm}$	1000 $\mu\text{S}/\text{cm}$	10mS/cm	100mS/cm	1000mS/cm
0.01	0.01 $\mu\text{S}/\text{cm}$ to 200 $\mu\text{S}/\text{cm}$				200 $\mu\text{S}/\text{cm}$ to 6000 $\mu\text{S}/\text{cm}$				
0.1	0.1 $\mu\text{S}/\text{cm}$ to 2000 $\mu\text{S}/\text{cm}$				2000 $\mu\text{S}/\text{cm}$ to 60 mS/cm				
1.0	1 $\mu\text{S}/\text{cm}$ to 20mS/cm				20 mS/cm to 600 mS/cm				
4-electrode					2 $\mu\text{S}/\text{cm}$ to 1400 mS/cm				

Temperature Specifications:

Temperature range	0-200 $^\circ\text{C}$
Temperature Accuracy, Pt-1000, 0-50 $^\circ\text{C}$	$\pm 0.1^\circ\text{C}$
Temperature Accuracy, Pt-1000, Temp. > 50 $^\circ\text{C}$	$\pm 0.5^\circ\text{C}$

Cell Constant Linearity

	$\pm 0.6\%$ of reading in recommended range
	+2 to -10% of reading outside high recommended range
	$\pm 5\%$ of reading outside low recommended range
	$\pm 4\%$ of reading in recommended range

1.5 Toroidal Conductivity (Codes -21 and -31)

Measures conductivity in the range of 1 (one) $\mu\text{S}/\text{cm}$ to 2,000,000 $\mu\text{S}/\text{cm}$ (2 S/cm). Measurement choices are conductivity, resistivity, total dissolved solids, salinity, and % concentration. Temperature compensation can be disabled, allowing the analyzer to display raw conductivity.

For more information concerning the use and operation of the toroidal conductivity sensors, refer to the product data sheets.

Performance Specifications- Analyzer

Measurement Range: see table below

Repeatability: $\pm 0.25\% \pm 5 \mu\text{S}/\text{cm}$ after zero cal

Salinity: uses Practical Salinity Scale

Total Dissolved Solids: Calculated by multiplying conductivity at 25 °C by 0.65

Five percent concentration curves: 0-12% NaOH, 0-15% HCl, 0-20% NaCl, 0-25% or 96-99.7% H₂SO₄. The conductivity concentration algorithms for these solutions are fully temperature compensated. For other solutions, the analyzer accepts as many as five data points and fits either a linear (two points) or a quadratic function (three or more points) to the data.

Reference temperature and linear temperature slope may also be adjusted for optimum results.

Three temperature compensation options: manual slope (X% / °C), neutral salt (dilute sodium chloride) and raw.

Input filter: time constant 1 - 999 sec, default 2 sec.

Response time: 3 seconds to 95% of final reading

Recommended Sensors:

All Rosemount submersion/immersion and flow-through toroidal sensors.

Loop Performance (Following Calibration)

Temperature range	-25 to 210 °C (-13 to 410 °F)
Temperature Accuracy, Pt-100, -25 to 50 °C	$\pm 0.5 \text{ } ^\circ\text{C}$
Temperature Accuracy, Pt-100, 50 to 210 °C	$\pm 1 \text{ } ^\circ\text{C}$

	226: $\pm 1\%$ of reading $\pm 5 \mu\text{S}/\text{cm}$ in recommended range
	225 & 228: $\pm 1\%$ of reading $\pm 10 \mu\text{S}/\text{cm}$ in recommended range
	222, 242: $\pm 4\%$ of reading in recommended range
	225, 226 & 228: $\pm 5\%$ of reading outside high recommended range
	226: $\pm 5 \mu\text{S}/\text{cm}$ outside low recommended range
	225 & 228: $\pm 15 \mu\text{S}/\text{cm}$ outside low recommended range

PERFORMANCE SPECIFICATIONS Recommended Range - Toroidal Conductivity

Model	1 $\mu\text{S}/\text{cm}$	10 $\mu\text{S}/\text{cm}$	100 $\mu\text{S}/\text{cm}$	1000 $\mu\text{S}/\text{cm}$	10 mS/cm	100 mS/cm	1000 mS/cm	2000 mS/cm
226	5 $\mu\text{S}/\text{cm}$ to 500 mS/cm			500 mS/cm to 2000				
225 & 228	15 $\mu\text{S}/\text{cm}$ to 1500 mS/cm			1500 mS/cm to 2000 mS/cm				
242	100 $\mu\text{S}/\text{cm}$ to 2000 mS/cm							
222 (1in & 2in)	500 $\mu\text{S}/\text{cm}$ to 2000 mS/cm							

1.6 pH/ORP (Codes -22 and -32)

For use with any standard pH or ORP sensors. Measurement choices are pH, ORP, Redox, Ammonia, Fluoride or custom ISE. The automatic buffer recognition feature uses stored buffer pH values and their temperature curves for the most common buffer standards available worldwide. The analyzer will recognize the pH value of the buffer being measured and perform a self stabilization check on the sensor before completing the calibration. Manual or automatic temperature compensation is menu selectable. Change in process pH due to temperature can be compensated using a programmable temperature coefficient. For more information concerning the use and operation of the pH or ORP sensors, refer to sensor product data sheets. The 56 can also derive an inferred pH value. Inferred pH can be derived and displayed when two contacting conductivity sensors are used.

Performance Specifications (pH input) - Analyzer

Measurement Range [pH]: 0 to 14 pH

Accuracy: ± 0.01 pH

Diagnostics: glass impedance, reference impedance

Temperature coefficient: ± 0.002 pH / °C

Solution temperature correction: pure water, high pH (dilute base), Ammonia and custom

Buffer recognition: NIST (including non-NIST pH 7.01 buffer), DIN 19267, Ingold, Merck, and Fisher

Input filter: Time constant 1 - 999 sec, default 4 sec.

Response time: 5 seconds to 95% of final reading

Recommended Sensors for pH:

Compatible with standard pH sensors with and without integral preamps. Supports Smart pH sensors from Rosemount (includes Smart integral preamps).



General purpose and high performance pH 396PVP, 3900VP and 3300HT sensors

Performance Specifications (ORP input) - Analyzer

Measurement Range [ORP]: -1500 to +1500 mV

Accuracy: ± 1 mV

Temperature coefficient: ± 0.12 mV / °C

Input filter: Time constant 1 - 999 sec, default 4 sec.

Response time: : 5 seconds to 95% of final reading

Recommended Sensors for ORP:

Compatible with standard ORP sensors with and without integral preamps.

NOTE:

Some older sensor preamps may not be compatible with the 56 (contact the factory for details).

1.7 Flow (Code -23 and -33)

For use with most pulse signal flow sensors, the 56 user-selectable units of measurement include flow rates in GPM (gallons per minute), GPH (gallons per hour), cu ft/min (cubic feet per min), cu ft/hour (cubic feet per hour), LPM (liters per minute), LPH (liters per hour), or m³/hr (cubic meters per hour), and velocity in ft/sec or m/sec. When configured to measure flow, the unit also acts as a totalizer in the chosen unit (gallons, liters, or cubic meters). Dual flow instruments can be configured as a % recovery, flow difference, flow ratio, or total (combined) flow.

Performance Specifications - Analyzer

Frequency Range: 3 to 1000 Hz

Flow Rate: 0 - 99,999 GPM, LPM, m³/hr, GPH, LPH, cu ft/min, cu ft/hr.

Totalized Flow: 0 – 9,999,999,999,999 Gallons or m³, 0 – 999,999,999,999 cu ft.

Accuracy: 0.5%

Input filter: Time constant 0-999 sec., default 5 sec.

1.8 4-20 mA Current Input (Codes -23 and -33)

For use with any transmitter or external device that transmits 4-20 mA or 0-20 mA current outputs. Typical uses are for temperature compensation of live measurements (except ORP, turbidity and flow) and for continuous pressure input for continuous measurement of % oxygen gas. External input of atmospheric pressure for oxygen measurement allows continuous partial pressure compensation while the 56 enclosure is completely sealed.

Externally sourced current input is also useful for calibration of new or existing sensors that require temperature measurement or atmospheric pressure inputs. In addition to live continuous compensation of live measurements, the current input board can also be used simply to display and trend the measured temperature or the calculated partial pressure from the external device. This feature leverages the large display variables on the 56 as a convenience for technicians. Temperature can be displayed in °C or °F. Partial pressure can be displayed in inches Hg, mm Hg, atm (atmospheres), kPa (kiloPascals), bar or mbar. The current input board serves as a power supply for loop-powered devices that do not actively power their 4-20 mA output signals.

Performance Specifications

Measurement Range * [mA]: 0-20 or 4-20

Accuracy: ±0.03 mA

Input filter: Time constant 0-999 sec., default 5 sec.

* Current input not to exceed 22 mA

1.9 Chlorine (Code -24 and -34) Free and Total Chlorine

The 56 is compatible with the 499ACL-01 free chlorine sensor and the 499ACL-02 total chlorine sensor. The 499ACL-02 sensor must be used with the TCL total chlorine sample conditioning system. The 56 fully compensates free and total chlorine readings for changes in membrane permeability caused by temperature changes.

For free chlorine measurements, both automatic and manual pH corrections are available. For automatic pH correction, select code P and an appropriate pH sensor. For more information concerning the use and operation of the amperometric chlorine sensors and the TCL measurement system, refer to the product data sheets.

Performance Specifications - Analyzer

Resolution: 0.001 ppm or 0.01 ppm – selectable
Input Range: 0nA – 100 μ A
Automatic pH correction (requires Code P): 6.0 to 10.0 pH
Temperature compensation: Automatic or manual (0-50 °C).
Input filter: Time constant 1 - 999 sec, default 5 sec.
Response time: 6 seconds to 95% of final reading

Recommended Sensors

Chlorine: 499ACL-01 Free Chlorine or 499ACL-02 Total Chlorine
pH: The following pH sensor is recommended for automatic pH correction of free chlorine readings: 3900

Monochloramine

The 56 is compatible with the 499A CL-03 Monochloramine sensor. The 56 fully compensates readings for changes in membrane permeability caused by temperature changes. Because monochloramine measurement is not affected by pH of the process, no pH sensor or correction is required. For more information concerning the use and operation of the amperometric chlorine sensors, refer to the product data sheets.

Performance Specifications - Analyzer

Resolution: 0.001 ppm or 0.01 ppm – selectable
Input Range: 0 nA – 100 μ A
Temperature compensation: Automatic or manual (0-50 °C).
Input filter: Time constant 1 - 999 sec, default 5 sec.
Response time: 6 seconds to 95% of final reading

Recommended Sensors

Rosemount 499ACL-03 Monochloramine sensor

1.10 Dissolved Oxygen (Codes -25 and -35)

The 56 is compatible with the 499ADO, 499ATrDO, Hx438, Gx438 and BX438 dissolved oxygen sensors and the 4000 percent oxygen gas sensor. The 56 analyzer displays dissolved oxygen in ppm, mg/L, ppb, $\mu\text{g/L}$, % saturation, % O_2 in gas, ppm O_2 in gas. The analyzer fully compensates oxygen readings for changes in membrane permeability caused by temperature changes. An atmospheric pressure sensor is included on all dissolved oxygen signal boards to allow automatic atmospheric pressure determination during air calibration. Calibration can be corrected for process salinity if removing the sensor from the process liquid is impractical. The analyzer can be calibrated against a standard instrument. For more information on the use of amperometric oxygen sensors, refer to the product data sheets.

Performance Specifications - Analyzer

Resolution: 0.01 ppm; 0.1 ppb for 499A TrDO sensor (when $\text{O}_2 < 1.00$ ppm); 0.1%
Input Range: 0 nA – 100 μA
Temperature Compensation: Automatic or manual (0-50 $^{\circ}\text{C}$).
Input filter: Time constant 1 - 999 sec, default 5 sec
Response time: 6 seconds to 95% of final reading

Recommended Sensor

Rosemount amperometric membrane and steam-sterilizable sensors listed above

1.11 Dissolved Ozone (Code -26 and -36)

The 56 is compatible with the 499AOZ sensor. The 56 fully compensates ozone readings for changes in membrane permeability caused by temperature changes. For more information concerning the use and operation of the amperometric ozone sensors, refer to the product data sheets.

Performance Specifications - Analyzer

Resolution: 0.001 ppm or 0.01 ppm – selectable
Input Range: 0 nA – 100 μA
Temperature Compensation: Automatic or manual (0-35 $^{\circ}\text{C}$)
Input filter: Time constant 1 - 999 sec, default 5 sec.
Response time: 6 seconds to 95% of final reading

Recommended Sensor

Rosemount 499A OZ ozone sensor.



Dissolved Oxygen 499ADO sensor with Variopol connection



Dissolved Ozone 499AOZ sensors with Polysulfone body Variopol connection and cable connection

1.12 Turbidity (Codes -27 and -37)

The 56 instrument is available in single and dual turbidity configurations for the Clarity II turbidimeter. It is intended for the determination of turbidity in filtered drinking water. The other components of the Clarity II turbidimeter – sensor(s), debubbler/measuring chamber(s), and cable for each sensor must be ordered separately or as a complete system with the 56.

The 56 turbidity instrument accepts inputs from both USEPA 180.1 and ISO 7027-compliant sensors. Four fully programmable relays with timers are included.

Note: the 56 Turbidity must be used with Clarity II sensor, sensor cable and debubbler.

Performance Specifications - Analyzer

Units: Turbidity (NTU, FTU, or FNU); total suspended solids (mg/L, ppm, or no units)

Display resolution-turbidity: 4 digits; decimal point moves from x.xxx to xxx.x

Display resolution-TSS: 4 digits; decimal point moves from x.xxx to xxxx

Calibration methods: User-prepared standard, commercially prepared standard, or grab sample. For total suspended solids user must provide a linear calibration equation.

Inputs: Choice of single or dual input, EPA 180.1 or ISO 7027 sensors.

Field wiring terminals: Removable terminal blocks for sensor connection.

Accuracy after calibration at 20.0 NTU:

0-1 NTU $\pm 2\%$ of reading or 0.015 NTU, whichever is greater. 0-20 NTU: $\pm 2\%$ of reading.

1.13 Ordering Information

The 56 Analyzer offers single or dual sensor input with an unrestricted choice of dual measurement combinations. Measurements capabilities include pH/ORP, Resistivity/Conductivity, % Concentration, Total Chlorine, Free Chlorine, Monochloramine, Dissolved Oxygen, Dissolved Ozone, Turbidity, Pulse Flow, Temperature, and 4-20mA input.

The device includes two isolated inputs, nine local languages, four 4-20mA current outputs, removable connectors for power and current outputs, and four solid plugs for closure of openings. HART digital communications is included at no additional charge. Profibus digital communications is optional.

56 Advanced Dual-Input Analyzer

Level 1 POWER	
02	24 VDC with four alarm relays
03	85-265 VAC switching, 50/60 Hz with four alarm relays
Level 2 MEASUREMENT 1	
20	Contacting Conductivity
21	Toroidal Conductivity
22	pH/ORP
23	Flow/Current Input
24	Chlorine
25	Dissolved Oxygen
26	Ozone
27	Turbidity
Level 3 MEASUREMENT 2	
30	Contacting Conductivity
31	Toroidal Conductivity
32	pH/ORP/ISE
33	Flow/Current Input
34	Chlorine
35	Dissolved Oxygen
36	Ozone
37	Turbidity
38	None
Level 4 COMMUNICATIONS	
HT	HART® digital communication
DP	Profibus DP digital communication

Section 2.0 – Installation

2.1 Unpacking and Inspection

Inspect the shipping container. If it is damaged, contact the shipper immediately for instructions. Save the box. If there is no apparent damage, unpack the container. Be sure all items shown on the packing list are present. If items are missing, notify Rosemount immediately.

2.2 Installation

2.2.1 General Information

1. Although the transmitter is suitable for outdoor use, installation in direct sunlight or in areas of extreme temperatures is not recommended unless a sunshield is used. Make sure to note the Ambient temperature specifications in section 1. The analyzer cannot be operated in ambient (shaded) conditions greater than 60 °C.
2. Install the analyzer in an area where vibration and electromagnetic and radio frequency interference are minimized or absent.
3. Keep the analyzer and sensor wiring at least one foot from high voltage conductors. Be sure there is easy access to the analyzer.
4. The analyzer is suitable for panel, pipe, or surface mounting. See Figures 2-1 and 2-2.
5. Install cable gland fittings and plugs as needed to properly seal the analyzer on all six enclosure openings. The USB port cover must be fully installed on the front cover to ensure proper analyzer sealing.

WARNING

RISK OF ELECTRICAL SHOCK



Electrical installation must be in accordance with the National Electrical Code (ANSI/NFPA-70) and/or any other applicable national or local codes.



CAUTION: This symbol identifies a risk of electrical shock.



CAUTION: This symbol identifies a potential hazard. When this symbol appears, consult the manual for appropriate action.

Fig. 2-1 Panel Mounting Installation dimensions

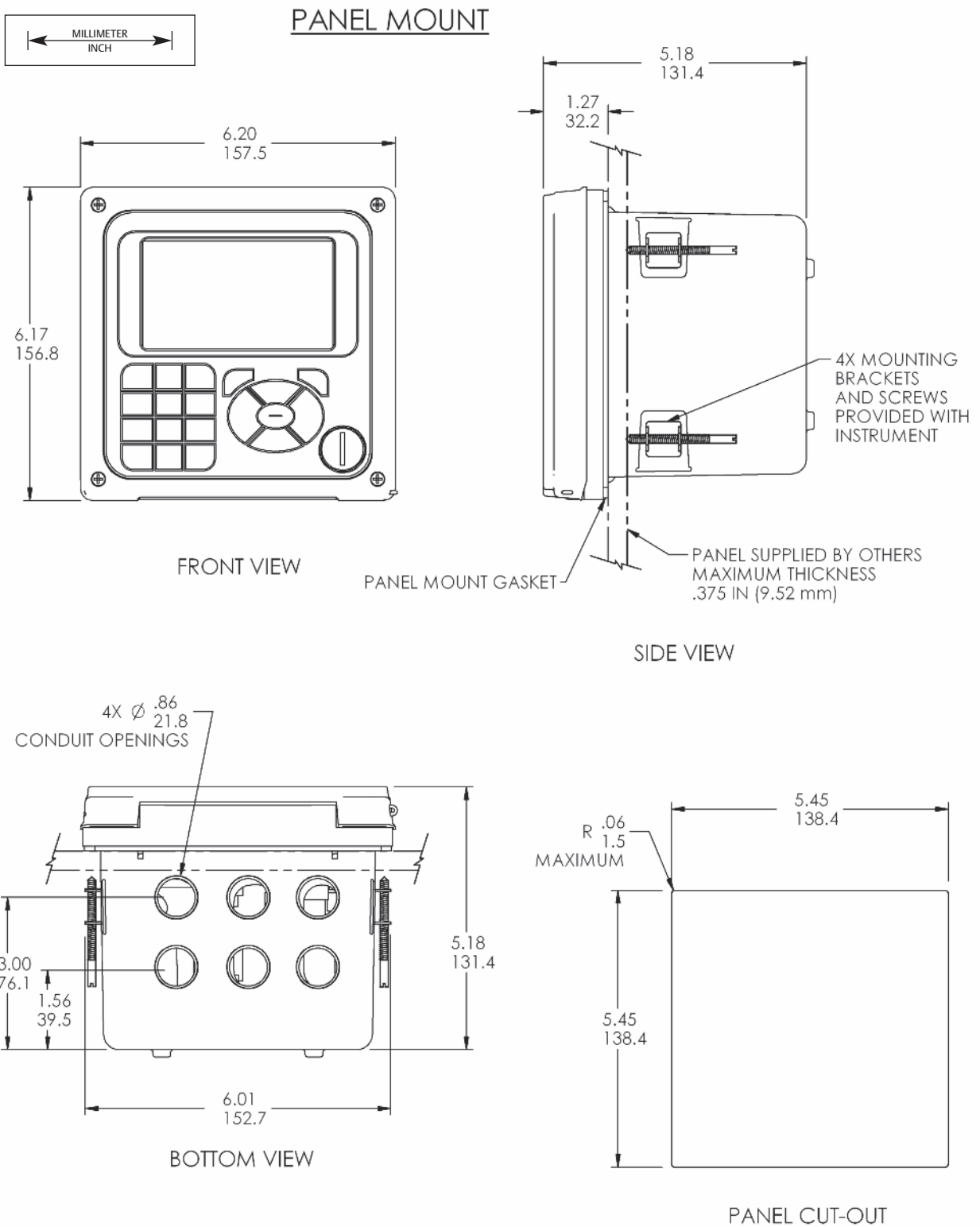

Fig. 2-2 Pipe and Wall Mounting Installation dimensions

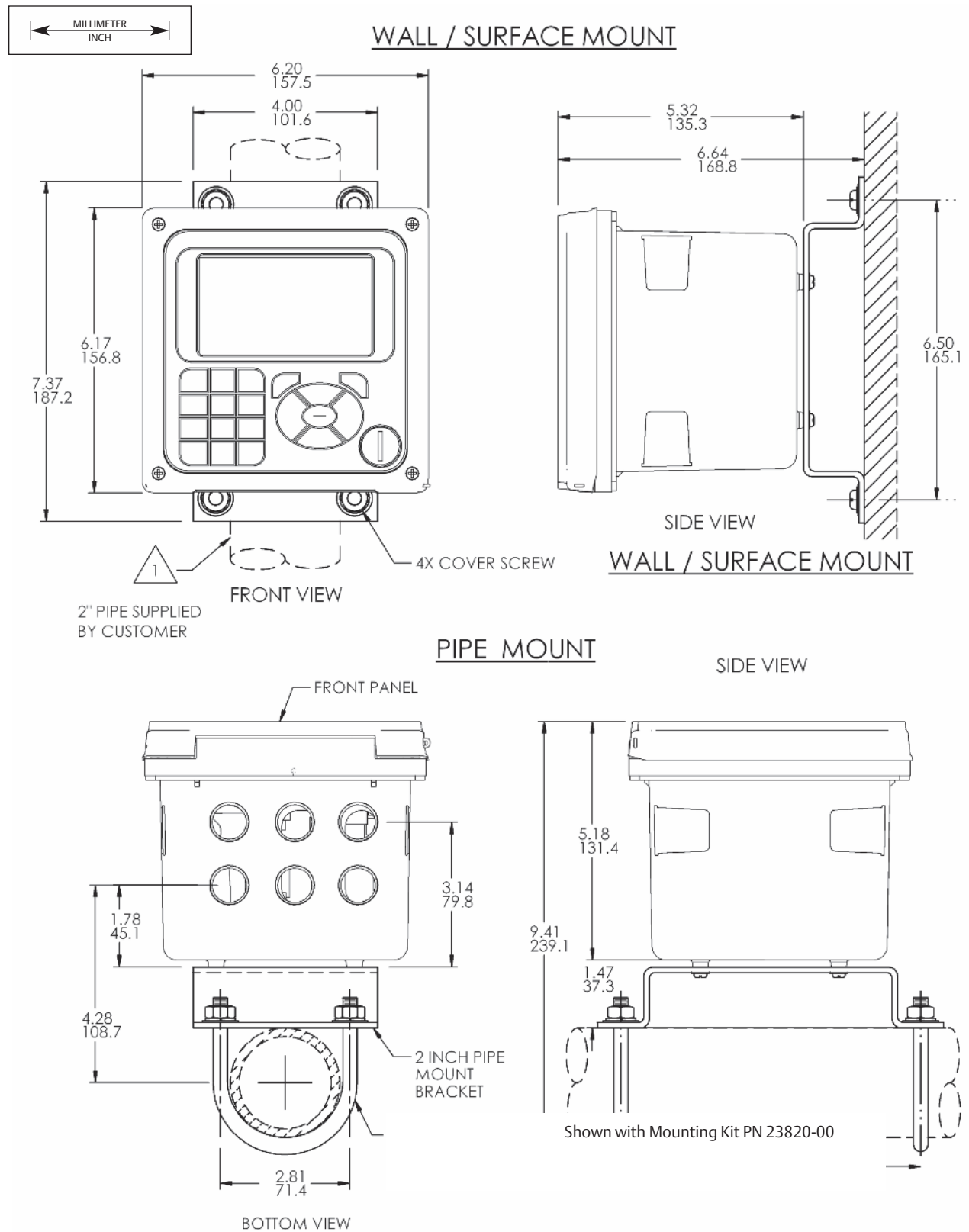
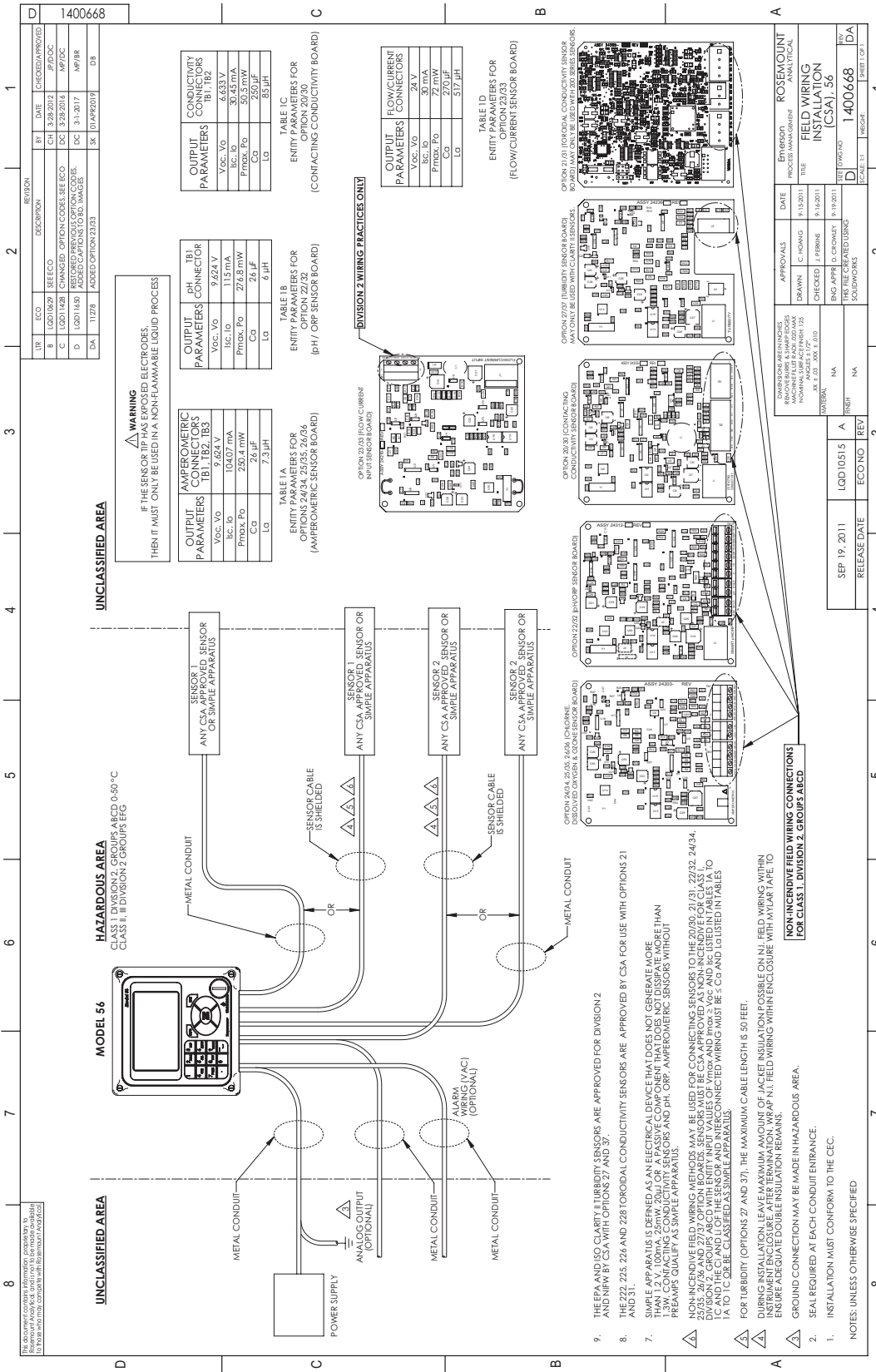

Fig. 2-4 CSA Non-incendive field wiring installation



Section 3.0 Wiring

3.1 General

The 56 is easy to wire. It includes removable connectors and slide-out signal input boards. The front panel is hinged at the bottom. The panel swings down for easy access to the wiring locations.

3.1.1 Removable connectors and signal input boards

The 56 uses removable signal input boards and communication boards for ease of wiring and installation. Each of the signal input boards can be partially or completely removed from the enclosure for wiring. The 56 has three slots for placement of up to two signal input boards and one communication board.

Slot 1-Left	Slot 2 – Center	Slot 3 – Right
Profi board	Signal Board 1	Signal Board 2

3.1.2 Signal input boards

Slots 2 and 3 are for signal input measurement boards. Wire the sensor leads to the measurement board following the lead locations marked on the board. After wiring the sensor leads to the signal board, carefully slide the wired board fully into the enclosure slot and take up the excess sensor cable through the cable gland. Tighten the cable gland nut to secure the cable and ensure a sealed enclosure.

NOTE:

For the purpose of replacing factory-installed signal input boards, Rosemount® Analytical Inc. is the sole supplier.

3.1.3 Digital communications

HART® digital communications is standard on 56. HART® versions 5 and 7 are available on the 56 and can be switched using the local keypad. A Profibus DP communication board is available as options for 56 communication with a host. HART communications supports Bell 202 digital communications over an analog 4-20 mA current output. Profibus DP is an open communications protocol which operates over a dedicated digital line to the host.

3.1.4 Alarm relays

Four alarm relays are supplied with the switching power supply (85 to 264 VAC, -03 order code) and the 24 VDC power supply (20-30 VDC, -02 order code). All relays can be used for process measurement(s) or temperature. Any relay can be configured as a fault alarm instead of a process alarm. Each relay can be configured independently and each can be programmed as an interval timer, typically used to activate pumps or control valves. As process alarms, alarm logic (high or low activation or USP*) and deadband are user-programmable. Customer-defined failsafe operation is supported as a programmable menu function to allow all relays to be energized or not-energized as a default condition upon powering the analyzer. The USP* alarm can be programmed to activate when the conductivity is within a user-selectable percentage of the limit. USP alarming is available only when a contacting conductivity measurement board is installed.

3.2 Preparing Conduit Openings

There are six conduit openings in all configurations of 56 analyzer. (Note that four of the openings will be fitted with plugs upon shipment.)

Conduit openings accept 1/2-inch conduit fittings or PG13.5 cable glands. To keep the case watertight, block unused openings with Type 4X or IP66 conduit plugs.

NOTE:

Use watertight fittings and hubs that comply with your requirements. Connect the conduit hub to the conduit before attaching the fitting to the analyzer.

3.3 Preparing Sensor Cable

The 56 is intended for use with all Rosemount sensors. Refer to the sensor installation instructions for details on preparing sensor cables.

3.4 Power, Output, and Sensor Connections

3.4.1 Power wiring

Two Power Supplies are offered for the 56:

- a. 24 VDC (20 – 30V) Power Supply (-02 order code)
- b. 85 – 265 VAC Switching Power Supply (-03 order code)

AC mains leads and 24 VDC leads are wired to the Power Supply board which is mounted vertically on the left side of the main enclosure cavity. Each lead location is clearly marked on the Power Supply board. Wire the power leads to the Power Supply board using the lead markings on the board.

The grounding plate is connected to the earth terminal of the -03 order code (85-265 VAC) power supply. The green colored screws on the grounding plate are intended for connection to some sensors to minimize radio frequency interference. The green screws are not intended to be used for safety purposes.

3.4.2 Current output wiring

All instruments are shipped with four 4-20 mA current outputs. Wiring locations for the outputs are on the Main board which is mounted on the hinged door of the instrument. Wire the output leads to the correct position on the Main board using the lead markings (+/positive, -/negative) on the board. Male mating connectors are provided with each unit.

NOTE:

Twisted pairs are required to minimize noise pickup in the 4-20 mA current outputs. For high EMI/RFI environments, shielded sensor wire is required and recommended in all other installations.

3.4.3 Alarm relay wiring

Four alarm relays are supplied with the switching power supply (85 to 265 VAC, -03 order code) and the 24 VDC power supply (20-30 VDC, -02 order code). Wire the relay leads on each of the independent relays to the correct position on the power supply board using the printed lead markings (NO/Normally Open, NC/Normally Closed, or Com/Common) on the board.

3.4.4 Sensor wiring to signal boards

Wire the correct sensor leads to the measurement board using the lead locations marked directly on the board. After wiring the sensor leads to the signal board, carefully slide the wired board fully into the enclosure slot and take up the excess sensor cable through the cable gland.

For best EMI/RFI protection use shielded output signal cable enclosed in an earth-grounded metal conduit. Connect the shield to earth ground. AC wiring should be 14 gauge or greater. Provide a switch or breaker to disconnect the analyzer from the main power supply. Install the switch or breaker near the analyzer and label it as the disconnecting device for the analyzer.

Keep sensor and output signal wiring separate from power wiring. Do not run sensor and power wiring in the same conduit or close together in a cable tray.

WARNING



RISK OF ELECTRICAL SHOCK

Electrical installation must be in accordance with the National Electrical Code (ANSI/NFPA-70) and/or any other applicable national or local codes.



CAUTION: This symbol identifies a risk of electrical shock.

CAUTION: This symbol identifies a potential hazard. When this symbol appears, consult the manual for appropriate action.

NOTE:

Twisted pairs are required to minimize noise pickup in the Flow and Current sensor inputs. For high EMI/RFI environments, shielded sensor wire is required and recommended in all other installations.

FIGURE 3-1 Power Wiring for 56 24 VDC Power Supply (-02 order code) PN 24365-00

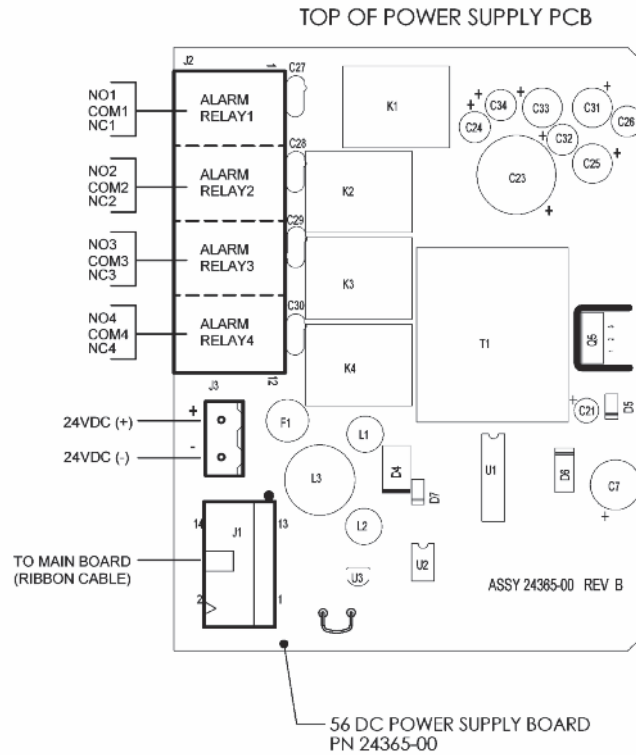

FIGURE 3-2 Power Wiring for 56 85-264 VAC Power Supply (-03 order code) PN 24358-00

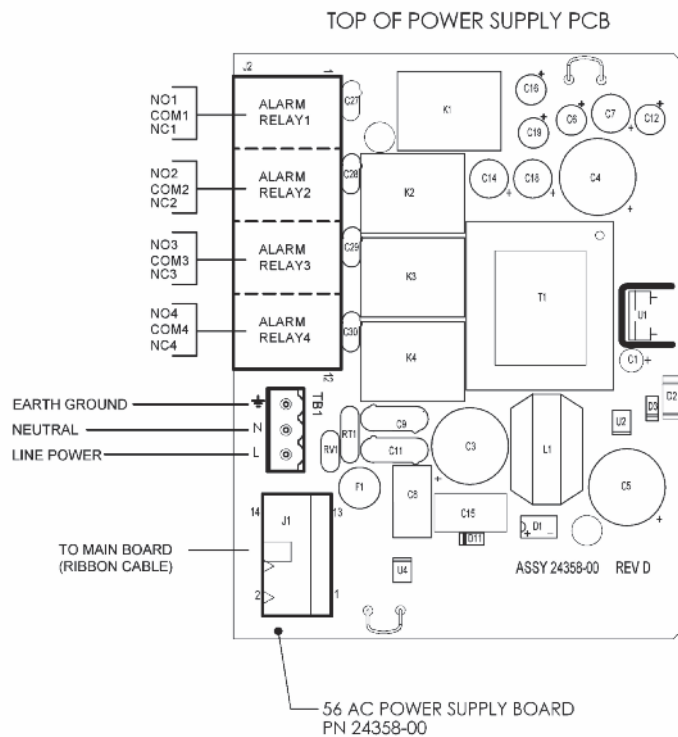

FIGURE 3-3 Output Wiring for 56 Main PCB PN 24308-00

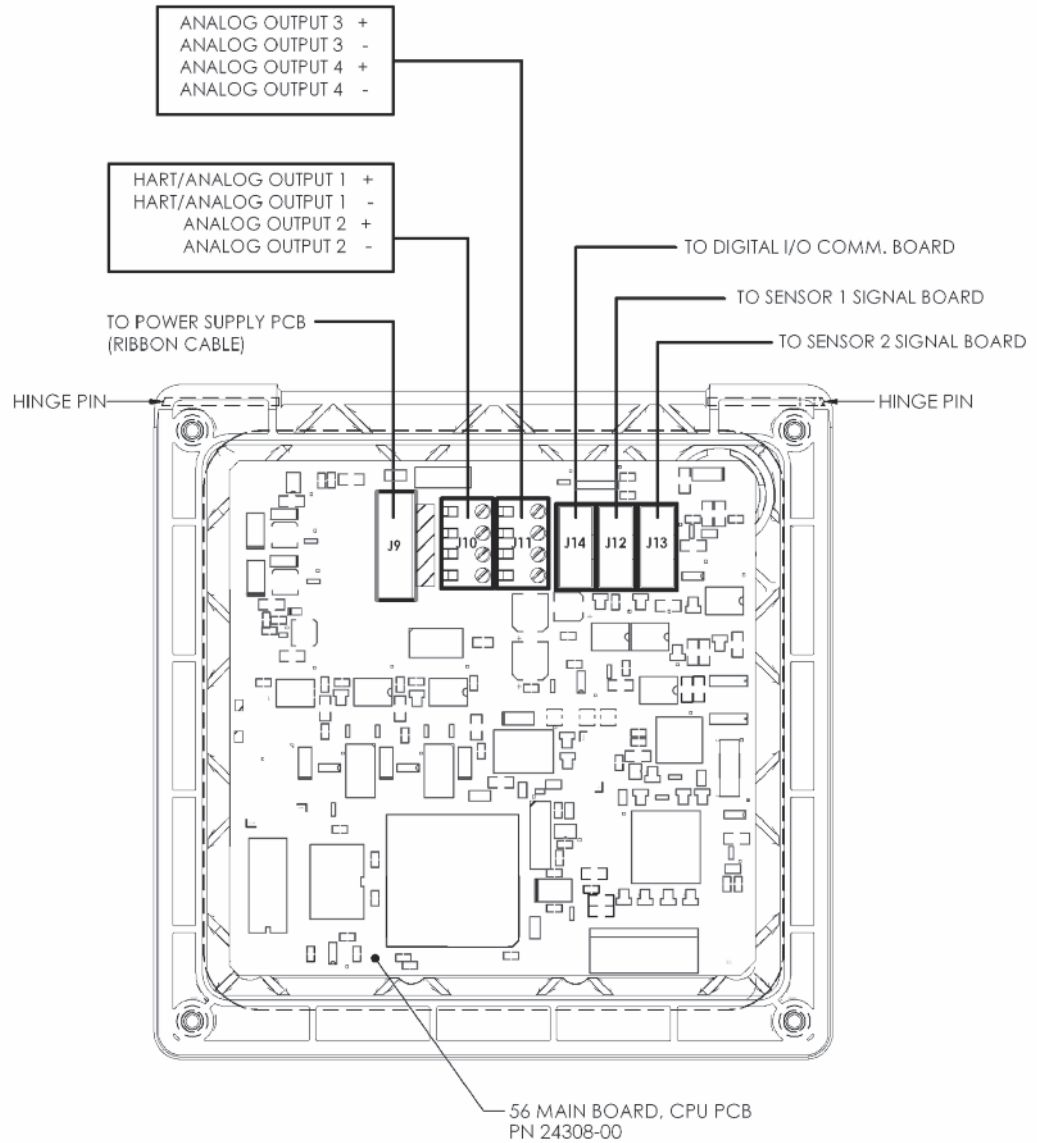

Figure 3-4 56 Recommended Wire Entry Points

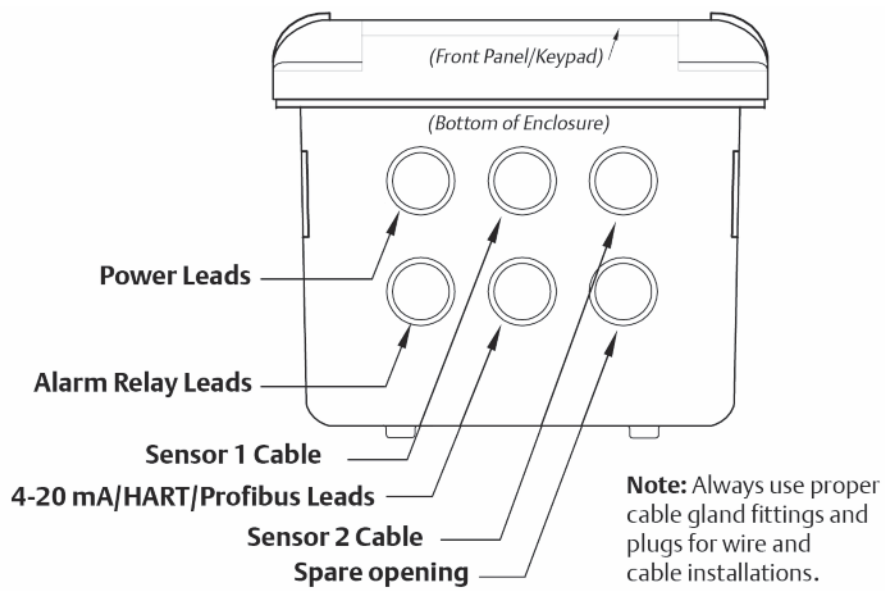

Figure 3-5 56 Recommended Wire Entry and THUM Adaptor Installation

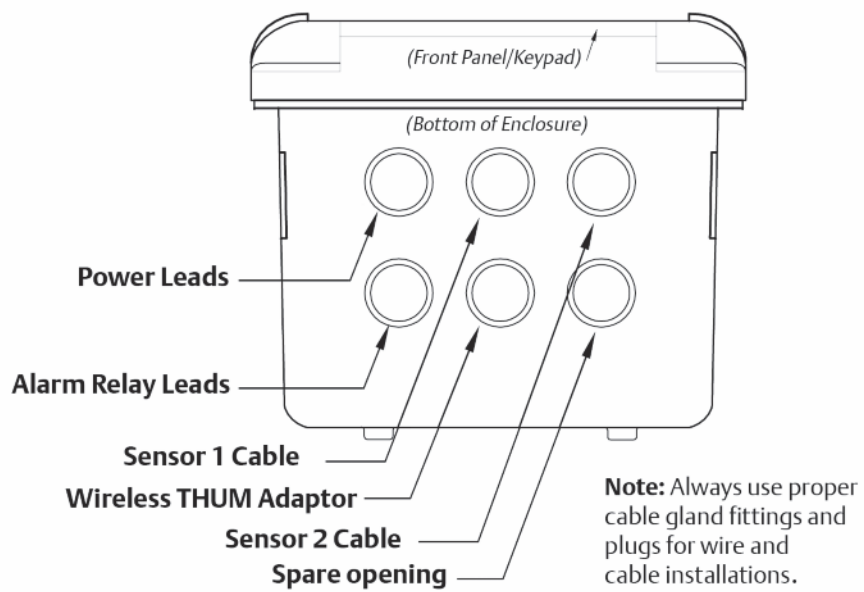

Figure 3-6 Contacting Conductivity signal board and Sensor Cable Leads

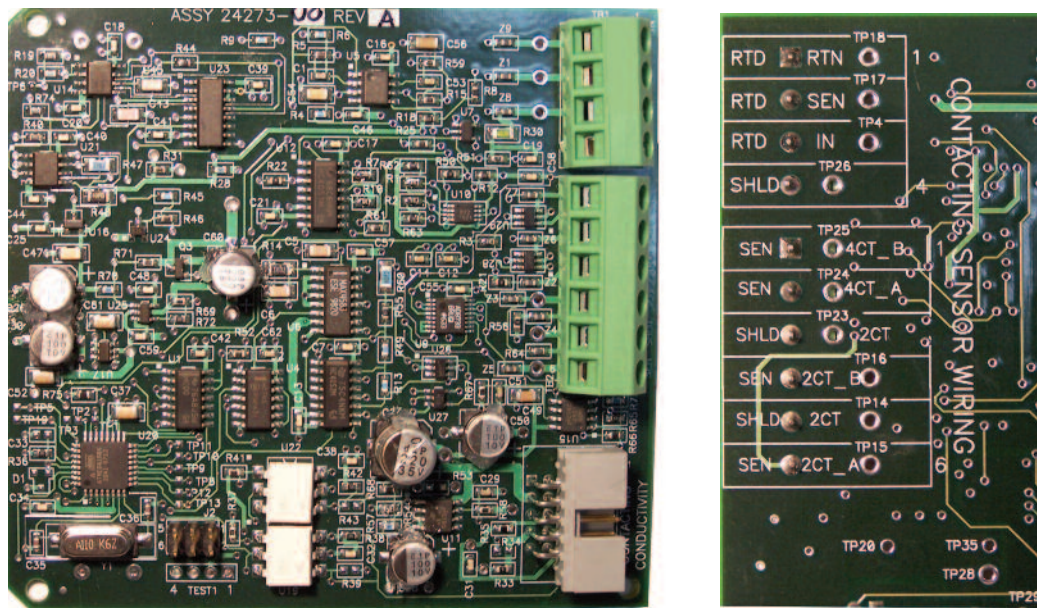

Figure 3-7 Toroidal Conductivity Signal board and Sensor Cable Leads

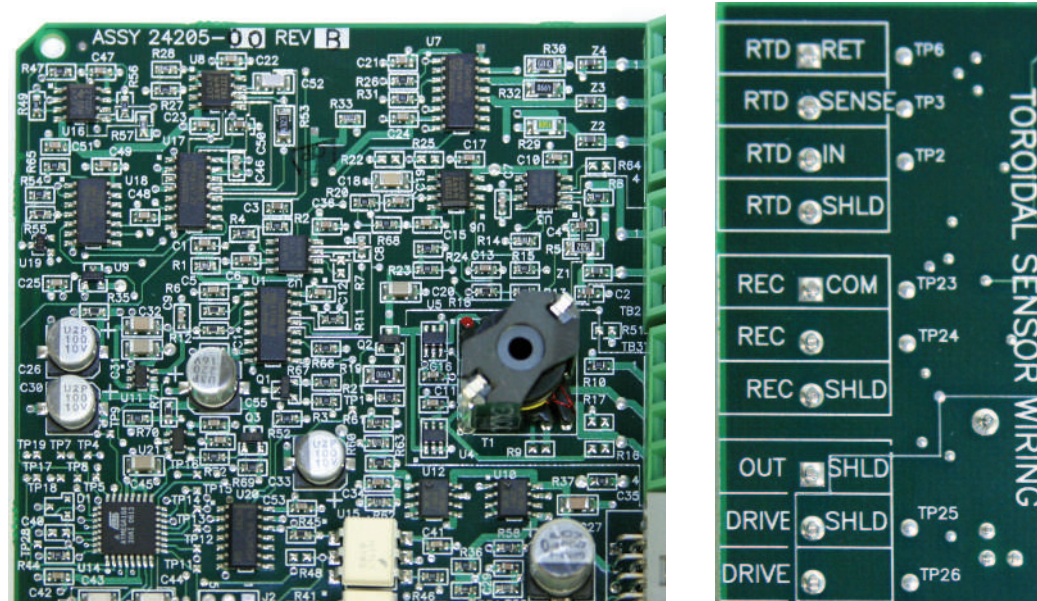

Figure 3-8 pH/ORP/ISE Signal Board and Sensor Cable Leads

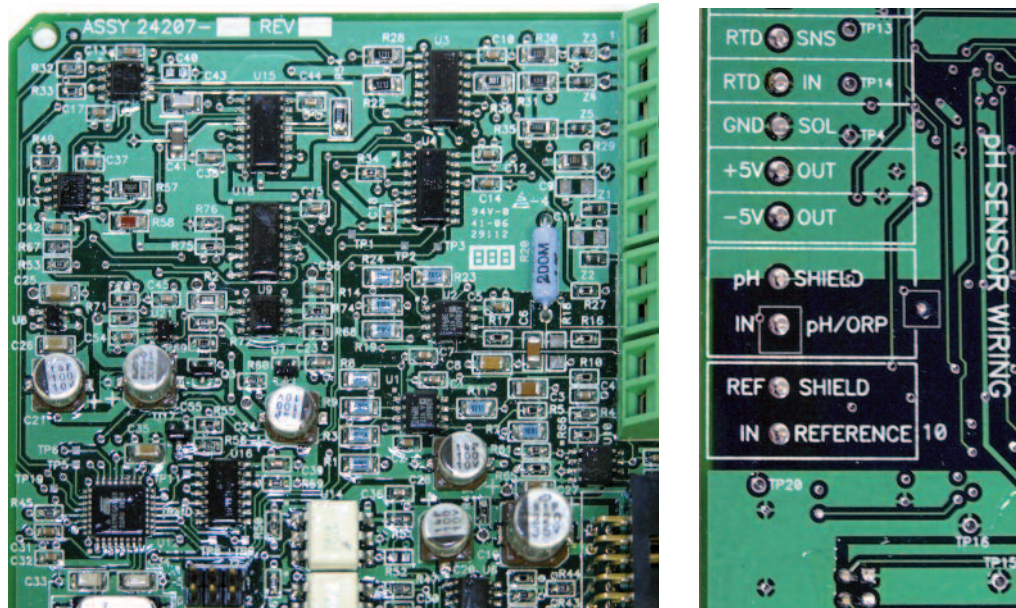

Figure 3-9 Amperometric signal (Chlorine, Oxygen, Ozone) board and Sensor cable leads

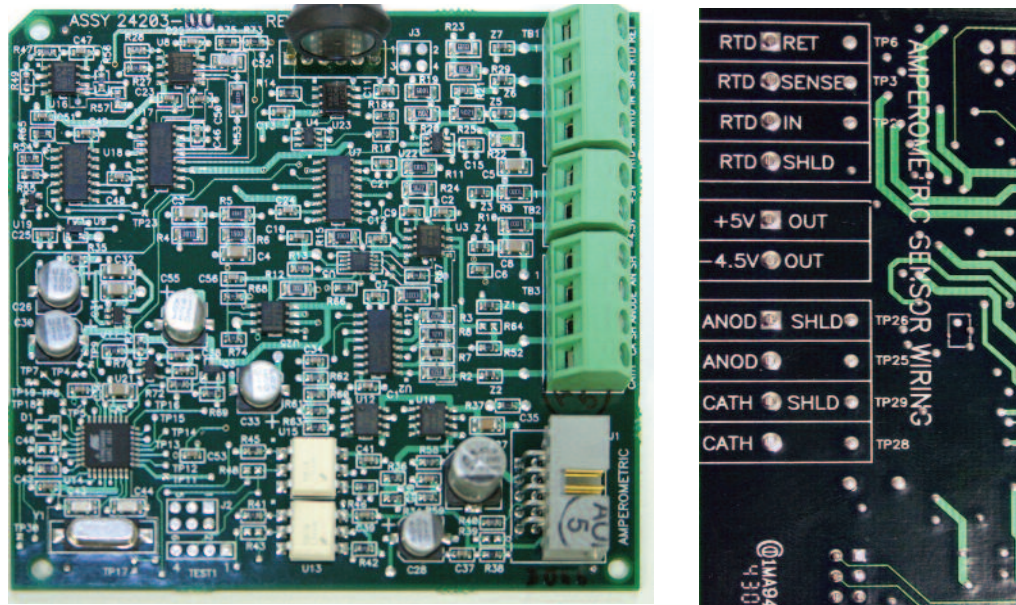

Figure 3-10 Turbidity Signal Board with Plug-in Sensor Connection

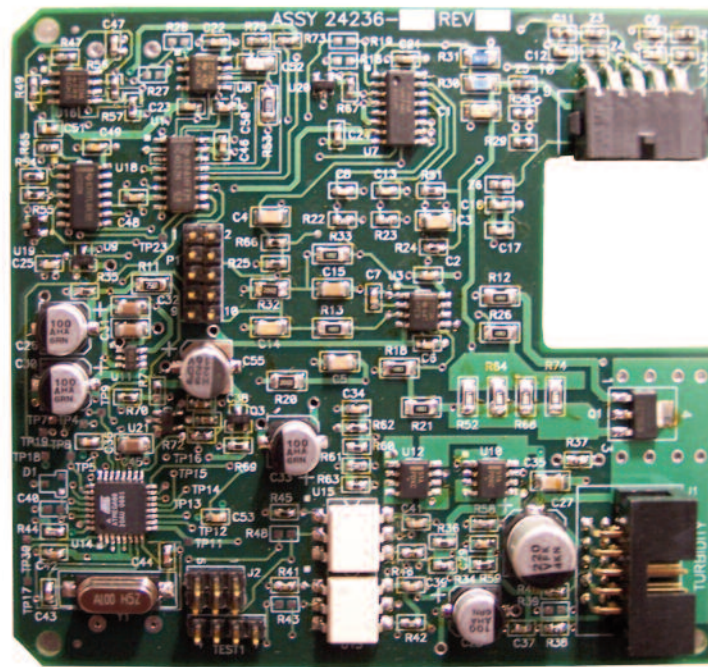
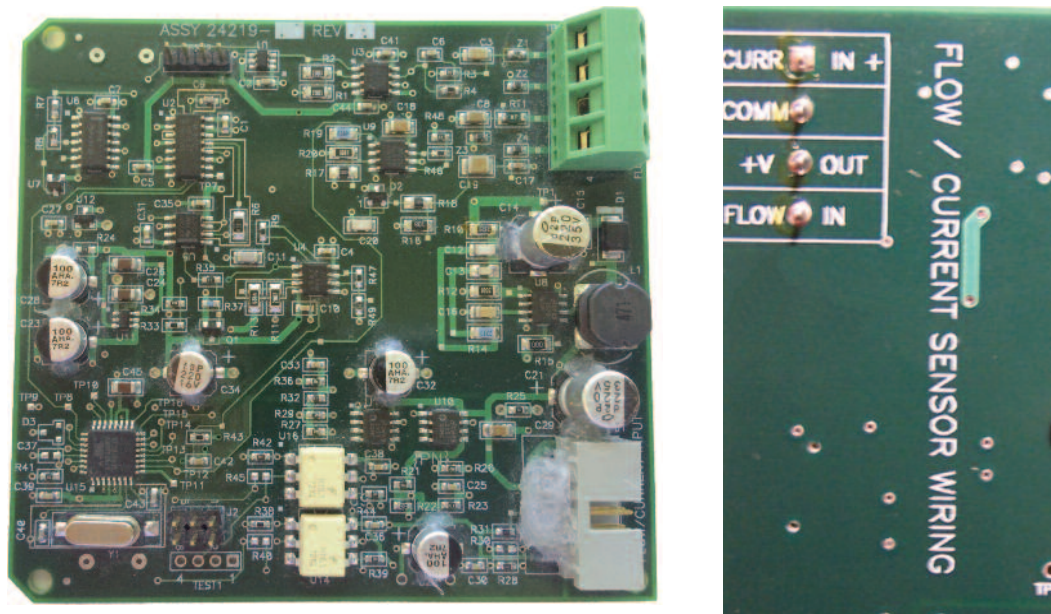

Figure 3-11 Flow/Current Input Signal Board and Sensor Cable Leads



Section 4.0 Display and Operation

4.1 User Interface

The 56 has a large display which shows two live measurement readouts in large digits and up to six additional process variables or diagnostic parameters concurrently. The display is back-lit and the format can be customized to meet user requirements. The ENTER/MENU key allows access to Calibration, Hold (of current outputs), Programming, Display, Data and HART® functions. In addition, a dedicated INFO key is available to provide access to useful diagnostic and instrument information regarding installed sensor(s) and any problematic conditions. The display flashes a red banner to indicate a Fault condition and a yellow banner for a Warning condition. Help screens are displayed for fault and warning conditions to guide the user in troubleshooting. During calibration and programming, key presses guide the user step-by-step through procedures. An alpha-numeric keypad similar to a cell phone keypad is available to allow the user to enter data during programming and calibration or lengthy tags to describe process points, sensors, or instrumentation.



4.2 Instrument Keypad

There are three Function keys, four Navigation keys and an alpha-numeric keypad on the instrument keypad.

Function keys

The ENTER/MENU key is used to access menus for programming and calibrating the instrument as well as retrieving stored data. Eight top-level menu items appear when pressing the ENTER/MENU key from the main display of live readings:

- Calibrate: calibrate attached sensors and analog outputs.
- Program: Program outputs, relays, measurement, temperature, and security codes.
- Hold: Suspend current outputs.
- Display Setup: Program graphic trend display, brightness, main display format, tags, language, and warnings.
- Data storage and retrieval: Enable data and event storage, download data, and view events.
- HART or Profibus: Program HART and Profibus communication parameters.
- Time and Date: Set and view real-time clock settings.
- Reset: Reset all instrument settings, calibration settings or current outputs to factory defaults.

Calibrate	Data storage and retrieval
Program	HART
Hold	Time and Date
Display setup	Reset
Software upgrade	

The ENTER/MENU key is also used to enter selections or enable programming and calibration steps.

The EXIT key returns to the previous menu level.

The INFO key provides detailed instructions and explanations during programming and calibrating procedures. It also provides troubleshooting tips for all faults and warnings that may occur during calibration or continuous operation in process.

Navigation Keys

The four Navigation keys arranged around the ENTER/MENU key operate in an intuitive manner similar to the navigation keys on a computer keyboard. During menu operation, these keys are used to move the highlighted screen selection to another adjacent screen item. During tag entry, the left key is used to delete entries during active alpha-numeric character entry.

Alpha-numeric Keypad

The alpha-numeric keypad has 12 keys as outlined below.

- Nine keys are alpha-numeric
- One key is a dedicated “1” key
- One key is a dedicated “0” key
- One key is a dedicated “.” (decimal point) key

The alpha-numeric keypad operates the same as entries on a mobile phone. The nine alpha-numeric keys have multiple characters that can be entered for tag entries or during programming and calibration steps. Character selections are made by pressing the key multiple times to toggle to characters that are available on each key.

4.3 Main Display

The 56 displays one or two primary measurement values, up to six secondary measurement values, fault and warning banner, alarm relay flags, and a digital communications icon.

Process Measurements:

Two process variables are displayed if two signal boards are installed. One process variable and process temperature is displayed if one signal board is installed with one sensor. The Upper display area shows the Sensor 1 process reading. The Center display area shows the Sensor 2 process reading. For dual conductivity, the Upper and Center display areas can be assigned to different process variables as follows:

For single input configurations, the Upper display area shows the live process variable and the Center display area can be assigned to Temperature or blank.

Secondary Values:

Up to six secondary values are shown in six display quadrants at the bottom half of the screen. All six secondary value positions can be programmed by the user to any display parameter available. Possible secondary values include:

4.4 Menu System

The 56 menu system is similar to a computer. Pressing the ENTER/MENU key at any time opens the top-level menu including Calibration, Hold, Programming, Display, Data and

HART functions. To find a menu item, use the directional Navigation keys to highlight a menu item. Press ENTER/MENU and simply direct the cursor to the desired operation and follow the screen prompts. Pressing the BACK screen control available on some menu screens will revert to the immediate previous menu screen. Pressing the EXIT key will return to the previous hierarchical menu level.

Fault and Warning banner:

If the analyzer detects a problem with itself or the sensor the word Fault banner (red) and/or Warning banner (yellow) will appear at the bottom of the main display. A fault requires immediate attention. A warning indicates a problematic condition or an impending failure. For detailed troubleshooting assistance, press INFO.

4.5 USB Data Port

The 56 menu system is similar to a computer. A USB 2.0 data port is accessible on the front panel of the 56 instrument. The USB data port can be used for download of measurement data and events using a USB memory device. It can also be used to download and upload complete analyzer configurations to copy all programmed settings to another 56 analyzer. NOTE: only 56 units which display the “Transfer Configurations” tab under the Data Storage and Retrieval menu are capable of downloading and uploading analyzer configurations.

The USB data port is easily accessed by inserting a coin in the vertical slot of the cover and rotating counterclockwise one quarter turn to remove the cover and Type 4 seal.

Caution: not all USB memory devices will physically fit into the 56 data port. After removing the USB cover and seal, make sure that the USB memory device can be easily and fully inserted into the USB data port without any mechanical conflict with the USB data port flange. The USB communications port is protected by a Type 4-rated seal and cover. Do not remove the cover during cleaning of the analyzer housing. Never remove the USB port cover when the instrument is operated in a hazardous rated area.

NOTE: the data logger and event logger are disabled by default setting upon initial startup from the factory. Always enable the data logger and event logger under the “Data Storage and Retrieval” menu to initiate internal recording of process data and event data.

4.6 56 Data Logger and Event Logger Download Procedure

4.6.1 Description

The 56 supports download of stored data logger and event logger data at the device. The download process is performed using a USB 2.0 flash drive memory device inserted into the USB data port on the front panel of the 56 analyzer. The data can be uploaded to a PC for viewing in preformatted EXCEL tables.

4.6.2 56 Data Logger Download Procedure

1. From the main menu, select Data storage and retrieval.
2. Select the Download tab.
3. Select “Download measurement” data.

4. With the 56 analyzer powered, remove the NEMA cap from the front display by inserting a coin into the cap's vertical slot and rotating counterclockwise. Remove the USB cap to access the data port.
5. Carefully insert a USB 2.0 flash drive into the USB port on the 56. Note that the USB insertion connector is keyed.
6. The Download screen will report Earliest data available and Latest data available that can be downloaded from the internal data logger file.
7. With a USB 2.0 flash drive properly inserted, choice Selected Range (default) or All Data.
8. If Selected Range is chosen, define the Start Date and End Date in the screen fields. Note that the Start Date and End Date reported will default to the current data that is recognized by the analyzer.
9. If All Data is selected, all stored date (up to 30 days) will be downloaded.
10. Select START and press ENTER.
11. A Data download information and instruction screen is displayed while data logger files are being downloaded. The download process will be completed in a few minutes.
12. When the data logger download is complete, a confirmation screen is display with the reported range of dates that were downloaded to the USB flash drive.
13. Carefully remove the USB 2.0 flash drive from the USB port.
14. Insert the NEMA cap into the 56 USB front display opening.
15. You may exit the Download completed screen by selecting BACK.
16. To view data logger files, insert the USB flash drive into a computer. On the designated drive associated with the USB flash drive, individual data logger files for each day can be opened as EXCEL formatted files in the root directory of the USB drive. Note that the data codes are assigned file names based on the analyzer's recognized dates.

4.6.3 56 Event Logger Download Procedure

1. From the main menu, select Data storage and retrieval.
2. Select the Download tab.
3. Select "Download events".
4. With the 56 analyzer powered, remove the NEMA cap from the front display by inserting a coin into the cap's vertical slot and rotating counterclockwise. Remove the USB cap to access the data port.
5. Carefully insert a USB 2.0 flash drive into the USB port on the 56. Note that the USB insertion connector is keyed.
6. A Download events information screen is briefly displayed while events files are being downloaded. The download process may require a few minutes to complete.
7. When the events download is complete, a confirmation screen appears.
8. Carefully remove the USB 2.0 flash drive from the USB port.
9. Insert the Type 4 cap into the 56 USB front display opening.
10. You may exit the Download completed screen by selecting BACK.
11. To view event logger files, insert the USB flash drive into a computer. On the designated drive associated with the USB device, the single event logger file can be opened as an EXCEL formatted file in the root directory of the USB drive. Note that the data codes are assigned file names based on the analyzer's recognized dates.

4.7 Software Upgrade

4.7.1 Description

All 56 advanced analyzers with serial number J12- or later (October 2012) allow software upgrades using the device's USB data port. To download and install software upgrades, refer to [Liquid Software Download](#).

4.7.2 Software upgrade checklist

Before upgrading, please confirm:

- Serial Number date codes of the 56 analyzer is J12 (October 2012) or later.
- Confirm that Safe Area requirements are met before installing software
- USB 2.0 flash drive memory device is available

4.7.3 Software upgrade procedure

1. Download the 56 software upgrade file to a computer. Access software [HERE](#). Save the file to the main root directory of a USB flash drive memory stick. Only one 56 software upgrade file should be present at the root directory.
2. Save all user settings before upgrading the software by copying the analyzer's configuration to a flash drive. Access this procedure at the local 56 device menu location: MENU/Data storage and retrieval/Transfer Configuration.
3. Download the Data Logger measurement data and the Events before upgrading the software. Access these procedures at 56 menu location: MENU/Data storage and retrieval/Download/Download measurement data and at /Download/Download Events.
4. With the 56 analyzer powered up and the front enclosure panel completely closed, remove the Type 4 cap from the front display by inserting a coin into the cap's vertical slot and rotating counterclockwise. Remove the USB cap and seal to access the data port.
5. Carefully insert a USB 2.0 flash drive into the USB port on the 56. The USB insertion connector is keyed. Note that some USB devices will not fit into the USB port due to mechanical restrictions.
6. Press the ENTER/MENU key. Select Software upgrade in the main menu.
7. Select NEXT. Press ENTER/MENU to start software upgrade. The current software version and the new software version are reported on the screen.
8. Select NEXT. Press ENTER/MENU. "Software upgrade in process" and a progress bar will appear. The process may require up to 5 minutes to complete.
9. The Time and Date screen will appear. Enter local real time clock and date information. Press ENTER/MENU.
10. The main screen will appear reporting live process values. Programming of settings and calibration may be required.

4.8 Configuration Transfer

4.8.1 Description

All 56 unit with serial number J12- or later (October 2012) will support the function of Configuration Transfer from one 56 analyzer to another, or multiple 56 analyzers. The

transfer is done by using a version 2.0 USB flash drive (USB memory stick) for downloading the existing configuration and uploading to another instrument.

4.8.2 Transfer Configuration Process User Notes

1. Configuration Transfer can only be performed between instruments of identical configuration. The analyzers must have the same signal boards installed.
2. Several text files downloaded to the flash drive can be saved to a PC and used later.
3. Only one set of configuration files will be stored on the flash drive. The files that are downloaded will over-write any existing files stored in the root directory of the flash drive.

4.8.3 Transfer Configuration Procedure - User Notes

1. Confirm all user settings before transferring configuration.
2. From the main menu, select Data storage and retrieval.
3. Select the Transfer Configuration tab
4. Select “Copy analyzer configuration to the flash drive”.
5. With the 56 analyzer powered, remove the NEMA cap from the front display by inserting a coin into the cap’s vertical slot and rotating counterclockwise. Remove the USB cap to access the data port.
6. Carefully insert a USB 2.0 flash drive into the USB port on the 56. Note that the USB insertion connector is keyed.
7. Select Copy data. Press ENTER.
8. An information screen appears warning users that any configuration files that exist in the root directly of the flash drive will be over-written upon configuration transfer. If No is selected (default setting), existing configuration files will not be overwritten. Select Yes to transfer the configuration file to the flash drive.
9. The configuration file will be transferred (downloaded) in about 20 seconds. A screen will report that the configuration file has been transfused.
10. Carefully remove the USB 2.0 flash drive from the USB port.
11. Insert the NEMA cap into the 56 USB front display opening.
12. Follow steps 2-3 above on the instrument that will receive the copied configuration.
13. On the 56 analyzer instrument that will receive the copied configuration, remove the Type 4 cap from the front display.
14. Carefully insert the USB 2.0 flash drive containing the configuration file into the USB port.
15. Select “Copy configuration from the flash drive to the analyzer”. Press ENTER.
16. You have two options for configuration transfer. Select one of the following and press ENTER:
 - a. Copy configuration data only to the analyzer.
 - b. Copy configuration and calibration data to the analyzer.
17. Select Copy data. Press ENTER.
18. The configuration file will be transferred (uploaded) in about 20 seconds. A screen will report that the configuration file has been transfused.
19. Carefully remove the USB 2.0 flash drive from the USB port.
20. Insert the NEMA cap into the 56 USB front display opening.

Section 5.0. Programming the Analyzer - Basics

5.1 General

Typical programming steps include the following listed procedures. Each of these programming functions are easily and quickly accomplished using the intuitive menu systems.

- Changing the measurement type, measurement units and temperature units.
- Choose temperature units and manual or automatic temperature compensation mode
- Configure and assign values to the current outputs
- Set a security code for two levels of security access
- Accessing menu functions using a security code
- Enabling and disabling Hold mode for current outputs
- Choosing the frequency of the AC power (needed for optimum noise rejection)
- Resetting all factory defaults, calibration data only, or current output settings only

5.2 Changing Startup Settings

To change the measurement type, measurement units, or temperature units that were initially entered in Quick Start, choose the Reset function or access the Program menus for sensor 1 or sensor 2. The following choices for specific measurement type, measurement units are available for each sensor measurement board.

TABLE 5-1. Measurements and Measurement Units

Signal board	Available measurements	Measurements units:
pH/ORP (-22, -32)	pH, ORP, Redox, Ammonia, Fluoride, Custom ISE	pH, mV (ORP) %, ppm, mg/L, ppb, µg/L, (ISE)
Contacting conductivity (-20, -30)	Conductivity, Resistivity, TDS, Salinity, NaOH (0-12%), HCl (0-15%), Low H2SO4, High H2SO4, NaCl (0-20%), Custom Curve	µS/cm, mS/cm, S/cm % (concentration)
Toroidal conductivity (-21, -31)	Conductivity, Resistivity, TDS, Salinity, NaOH (0-12%), HCl (0-15%), Low H2SO4, High H2SO4, NaCl (0-20%), Custom Curve	µS/cm, mS/cm, S/cm % (concentration)
Chlorine (-24, -34)	Free Chlorine, pH Independ. Free Cl, Total Chlorine, Monochloramine	ppm, mg/L
Oxygen (-25, -35)	Oxygen (ppm), Trace Oxygen (ppb), Percent Oxygen in gas, Salinity	ppm, mg/L, ppb, µg/L % Sat, Partial Pressure, % Oxygen In Gas, ppm Oxygen In Gas
Ozone (-26, -36)	Ozone	ppm, mg/L, ppb, µg/L
Temperature (all)	Temperature	°C / °F

To change the measurement type, measurement units, or temperature units, access the Reset screens by pressing ENTER/MENU from the main screen.

To change the measurement type, measurement units, or temperature units, access the Program screens by pressing ENTER/MENU from the main screen.

5.3 Programming Temperature

Most liquid analytical measurements (except ORP) require temperature compensation. The 56 performs temperature compensation automatically by applying internal temperature correction algorithms. Temperature correction can also be turned off. If temperature correction is off, the 56 uses the temperature entered by the user in all temperature correction calculations.

To select automatic or manual temp compensation, set the manual reference temperature, and to program temperature units as °C or °F, access the Temperature screens by pressing ENTER/MENU from the main screen.

5.4 Configuring and Ranging the Current Outputs

The 56 accepts inputs from two sensors and has four analog current outputs. Ranging the outputs means assigning values to the low (0 or 4 mA) and high (20 mA) outputs. This section provides a guide for configuring and ranging the outputs. ALWAYS CONFIGURE THE OUTPUTS FIRST.

To configure the outputs, access the Outputs screen by pressing ENTER/MENU from the main screen.

5.5 Setting a Security Code

The security codes prevent accidental or unwanted changes to program settings, displays, and calibration. The 56 has two levels of security code to control access and use of the instrument to different types of users.

The two levels of security are:

- **All:** This is the Supervisory security level. It allows access to all menu functions, including Programming, Calibration, Hold and Display.
- **Calibration/Hold:** This is the operator or technician level menu. It allows access to only calibration and Hold of the current outputs.

To set security codes, access the Security screen by pressing ENTER/MENU from the main screen. Upon entry of the proper code, the following security screen will appear.

5.6 Security Access

When entering the correct access code for the Calibration/Hold security level, the Calibration and Hold menus are accessible. This allows operators or technicians to perform routine maintenance. This security level does not allow access to the Program or Display menus. When entering the correct access code for All security level, the user has access to all menu functions, including Programming, Calibration, Hold and Display.

The 56 menus use a security code, access the Security screen by pressing ENTER/MENU from the main screen.

If a security code is currently programmed, the follow security screen will appear. Enter the code.

1. If a security code has been programmed, selecting the Calibrate, Hold, Program or Display top menu items causes the security access screen to appear.
2. Enter the three-digit security code for the appropriate security level.
3. If the entry is correct, the appropriate menu screen appears. If the entry is incorrect, the Invalid Code screen appears. The Enter Security Code screen reappears after 2 seconds.

5.7 Using Hold

The analyzer output is always proportional to measured value. To prevent improper operation of systems or pumps that are controlled directly by the current output, place the analyzer in hold before removing the sensor for calibration and maintenance. Be sure to remove the analyzer from hold once calibration is complete. During hold, all outputs remain at the last value. Once in hold, all current outputs remain on Hold indefinitely.

To hold the outputs and alarm relays, access the Hold screen by pressing ENTER/MENU from the main screen.

5.8 Resetting Factory Default Settings

This section describes how to restore factory calibration and default values. The process also clears all fault messages and returns the display to the first Quick Start screen. The 56 offers three options for resetting factory defaults.

- reset all settings to factory defaults
- reset sensor calibration data only
- reset analog output settings only

To reset to factory defaults, reset calibration data only or reset analog outputs only, access the Reset screen by pressing ENTER/MENU from the main screen.

5.9 Programming Alarm Relays

The 56 24 VDC (02 order code) and the AC switching power supply (03 order code) provide four alarm relays for process measurement or temperature. Each alarm can be configured as a fault alarm instead of a process alarm. Also, each relay can be programmed independently and each can be programmed as an interval timer or one of four advanced timer functions. This section describes how to configure alarm relays, simulate relay activation, and synchronize timers for the four alarm relays.

This section provides details to program the following alarm features. To program the alarm relays, access the Program screen by pressing ENTER/MENU from the main screen and then select the Relay tab and the Configure relay control.

The following relay functions can be programmed to any relay from the Configure Relay screen:

1. assign a relay
2. define a relay function
3. assign a Measurement
4. set relay logic
5. enter setpoints
6. set deadband
7. set normal state
8. set USP Safety level (contacting conductivity)

To program these relay functions, access the Configure Relay screen by pressing ENTER/MENU from the main Relay programming screen.

1. To assign a relay, highlight the desired Relay 1-4 and press ENTER/MENU.
2. To define a relay function, select from Setpoint, Interval Timer, TPC, Bleed and Feed, Water Meter, Delay timer, Date and Time, Fault or None and press ENTER/MENU.
3. To assign a measurement to a specific relay, select the desired measurement or temperature input and press ENTER/MENU.
4. To set relay logic to activate alarms at a High reading or a Low reading, select high or low and press ENTER/MENU.
5. To enter setpoints for relays, enter the desired value for the process measurement or temperature at which to activate an alarm event and press ENTER/MENU.
6. To set deadband as a measurement value, enter the change in the process value needed after the relay deactivates to return to normal (and thereby preventing repeated alarm activation) and press ENTER/MENU.
7. To set the Normal alarm condition, select Open or Closed and press ENTER/MENU. Program the normal state to define the desired alarm default state to normally open or normally closed upon power up.
8. To set USP Safety, enter the percentage below the limit at which to activate the alarm and press ENTER/MENU. NOTE: USP Safety only appears if a contacting conductivity board is installed.

The screenshot shows the 'Configure Relay' screen with the following settings:

- Relay: 1
- Type: Setpoint
- Assign: S1 Measurement
- Logic: High
- Setpoint: 14.00 pH
- Deadband: 0.00 pH

Navigation buttons: NEXT, BACK

This section provides details to simulate relay action. To simulate relays, access the Program screen by pressing ENTER/MENU from the main screen and then select the Relay tab.

To simulate alarm relay conditions, access the Simulate Relay Action screen by pressing ENTER/MENU from the main Relay programming screen.

Alarm relays can be manually set for the purposes of checking devices such as valves or pumps. Under the Alarms Settings menu, this screen will appear to allow manual forced activation of the alarm relays. Select the desired alarm condition to simulate.

S1: 7.00pH 25.2 °C		S2: 0.056 µS/cm 52.1 °C			
Outputs	Relays	Measure	Temperature	pH diagnostic setup	Security
Explanation of relay actions					
Configure relay					
Simulate relay action					
BACK					

S1: 7.00pH 25.2 °C		S2: 0.056 µS/cm 52.1 °C			
Outputs	Relays	Measure	Temperature	pH diagnostic setup	Security
Choose the relay to simulate					
Relay <input type="text" value="1"/>					
Energize relay					
De-energize relay					
Stop simulation					
Pressing BACK or EXIT also stops simulation.					
BACK					

Section 6.0 Programming - Measurements

6.1 Programming Measurements – Introduction

The 56 automatically recognizes each installed measurement board upon first power-up and each time the analyzer is powered. Completion of Quick Start screens upon first power up enable measurements, but additional steps may be required to program the analyzer for the desired measurement application. This section covers the following programming and configuration functions:

1. Selecting measurement type or sensor type (all sections)
2. Identifying the preamp location (pH-see Sec. 6.2)
3. Enabling manual temperature correction and entering a reference temperature (all sections)
4. Enabling sample temperature correction and entering temperature correction slope (selected sections)
5. Defining measurement display resolution (pH and amperometric)
6. Defining measurement display units (all sections)
7. Adjusting the input filter to control display and output reading variability or noise (all sections)
8. Selecting a measurement range (conductivity – see Sections 6.4, 6.5)
9. Entering a cell constant for a contacting or toroidal sensor (see Sec's 6.4, 6.5)
10. Entering a temperature element/RTD offset or temperature slope (conductivity-see Sec's 6.4)
11. Creating an application-specific concentration curve (conductivity-see Sec's 6.4, 6.5)
12. Enabling automatic pH correction for free chlorine measurement (Sec. 6.6.1)

To fully configure the analyzer for each installed measurement board, you may use the following:

1. Reset Analyzer function to reset factory defaults and configure the measurement board to the desired measurement. Follow the Reset Analyzer menu (Fig. 5-5) to reconfigure the analyzer to display new measurements or measurement units.
2. Program menus to adjust any of the programmable configuration items. Use the following configuration and programming guidelines for the applicable measurement.

6.2 pH Measurement Programming

The section describes how to configure the 56 analyzer for pH measurements. The following programming and configuration functions are covered.

1. Measurement type: pH Select pH, ORP, Redox, Ammonia, Fluoride, Custom ISE
2. Preamp location: Analyzer Identify preamp location
3. Filter: 4 sec Override the default input filter, enter 0-999 seconds
4. Reference Z: Low Select low or high reference impedance
5. Sensor wiring scheme: Normal or Reference to Ground
6. Resolution: 0.01pH Select 0.01pH or 0.1pH for pH display resolution

7. Enabling pH sensor diagnostics

To configure the pH measurement board, access the Program screen by pressing ENTER/MENU from the main screen and then select the Measurement tab.

- To Select a Measurement type, select from: pH, ORP, Redox, Ammonia, Fluoride, and Custom ISE and press ENTER/MENU.
- To program the Preamp location, select Analyzer or Sensor/JBox, and press ENTER/MENU.
- To Override the default input filter, enter 0-999 seconds and press ENTER/MENU.
- To program Reference Impedance. Select Low or High and press ENTER/MENU.
- To choose the wiring scheme, Select Normal or Reference to Ground and press ENTER/MENU.
- To program the display resolution, Select 0.01 pH or 0.1 pH and press ENTER/MENU.
- To enable pH sensor diagnostics, select the “pH diagnostic setup” tab under Programming. Select Sensor 1 or Sensor 2. Select NEXT. Select On under sensor diagnostics to enable pH diagnostics.

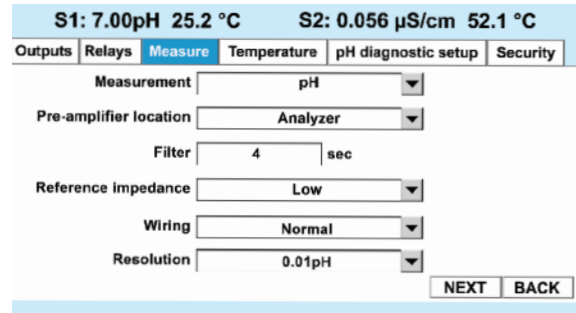

NOTE: pH sensor diagnostics must be enabled to include diagnostic values such as Glass Impedance and Reference Impedance in EXCEL data log sheets after data download to USB. Enabling pH sensor diagnostics also allows assignment of Glass Impedance and Reference Impedance to the two-dimensional on-screen process graph accessible under “Display Setup/View Graph”.

6.3 ORP Measurement Programming

The section describes how to configure the 56 analyzer for ORP measurements.

The following programming and configuration functions are covered:

- Measurement type: pH Select pH, ORP, Redox, Ammonia, Fluoride, Custom ISE
- Preamp location: Analyzer Identify preamp location
- Filter: 4 sec Override the default input filter, enter 0-999 seconds
- Reference Z: Low Select low or high reference impedance
- Sensor wiring scheme: Normal or Reference to Ground

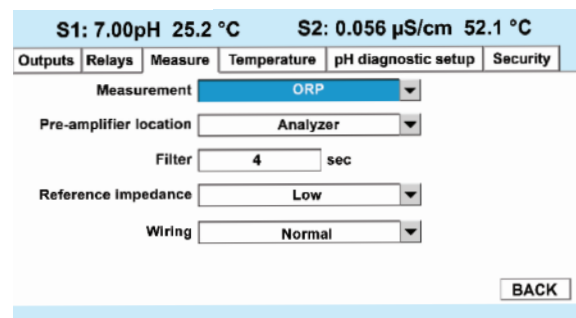

To configure the ORP measurement board, access the Program screen by pressing ENTER/MENU from the main screen and then select the Measurement tab.

- To Select a Measurement type, select ORP and press ENTER/MENU.
- To program the Preamp location, select Analyzer or Sensor/JBox, and press ENTER/MENU.
- To Override the default input filter, enter 0-999 seconds and press ENTER/MENU.

4. To program Reference Impedance. Select Low or High and press ENTER/MENU.
5. To choose the wiring scheme, Select Normal or Reference to Ground and press ENTER/MENU.

6.4 Contacting Conductivity Measurement Programming

The section describes how to configure the 56 analyzer for conductivity measurements using contacting conductivity sensors. The following programming and configuration functions are covered.

1. Measure: Conductivity, Select Conductivity, Resistivity, TDS. Salinity or % conc
2. Type: 2-Electrode Select 2-Electrode or 4-Electrode type sensors
3. Cell K: 1.00000/cm Enter the cell Constant for the sensor
4. Measurement units
5. Filter: 2 sec Override the default input filter, enter 0-999 seconds
6. Range: Auto Select measurement Auto-range or specific range
7. Temp Comp: Slope Select Temp Comp: Slope, Neutral Salt, Cation or Raw
8. Slope: 2.00% / °C Enter the linear temperature coefficient
9. Ref Temp: 25.0 °C Enter the Reference temp
10. Cal Factor: default=0.95000/cm Enter the Cal Factor for 4-Electrode sensors from the sensor tag

S1: -0.01µS/cm 999.9°C S2: 0.0000GPM

Outputs	Relays	Measure	Temperature	Security
		Measurement	Conductivity	
		Sensor type	2-Electrode	
		Units	uS/cm	
		Cell constant	1.00000 /cm	
		Filter	2 sec	
		Range	Auto	

NEXT BACK

Warning

To configure the contacting conductivity measurement board, access the Program screen by pressing ENTER/MENU from the main screen and then select the Measurement tab.

1. To program a Measurement type, select Conductivity Select Conductivity, Resistivity, TDS. Salinity or % conc. and press ENTER/MENU.
2. To program a sensor type, select 2-Electrode Select 2-Electrode or 4-Electrode type sensors and press ENTER/MENU.
3. To program the Cell constant, enter the exact cell constant value expressed as 1.XXXXX/cm the for the sensor and press ENTER/MENU.
4. To program Measurement units, select uS/cm or mS/cm and press ENTER/MENU.
5. To Override the default input filter, enter 0-999 seconds and press ENTER/MENU.
6. To program the measurement range, select a specific range appropriate for your process and press ENTER/MENU.
7. To program the Temp Comp method, choose Slope, Neutral Salt, Cation or Raw and press ENTER/MENU.

S1: -0.01µS/cm 999.9°C S2: 0.0000GPM

Outputs	Relays	Measure	Temperature	Security
		Temp compensation	Conductivity	
		Slope	2.000 %/°C	
		Reference temperature	25.0 °C	

NEXT BACK

Warning

8. To change the Temperature compensation Slope, enter the linear temperature coefficient expressed as X.XX% / °C and press ENTER/MENU.
9. To program the Reference Temperature for Manual temperature compensation (not from probe RTD), enter the Reference temp expressed as XX.X °C and press ENTER/MENU.
10. To program the Cal Factor for 4-Electrode sensors, enter the value shown on the sensor tag, expressed as X.XXXXX/cm and press ENTER/MENU.,

6.5 Toroidal Conductivity Measurement Programming

The section describes how to configure the 56 analyzer for conductivity measurements using inductive/toroidal sensors. The following programming and configuration functions are covered:

1. Measure: Conductivity Select Conductivity, Resistivity, TDS. Salinity or % conc
2. Sensor model: 228 Select sensor type
3. Measurement units
4. Cell K: 3.00000/cm Enter the cell Constant for the sensor
5. Temp Comp: Slope Select Temp Comp: Slope, Neutral Salt, Cation or Raw
6. Slope: 2.00% / °C Enter the linear temperature coefficient
7. Ref Temp: 25.0 °C Enter the Reference temp
8. Filter: 2 sec Override the default input filter, enter 0-999 seconds
9. Range: Auto Select measurement Auto-range or specific range

The screenshot shows the 'Measure' tab selected. At the top, it displays 'S1: -54µS/cm 999.9°C' and 'S2: 0.0000GPM'. Below the tabs, the following settings are visible:

- Measurement: Conductivity (dropdown)
- Model: 228 (dropdown)
- Units: uS/cm (dropdown)
- Cell constant: 3.00000 /cm
- Temp compensation: Slope (dropdown)
- Slope: 2.000 %/°C

Buttons for 'NEXT' and 'BACK' are located at the bottom right.

To configure the Contacting conductivity measurement board, access the Program screen by pressing ENTER/MENU from the main screen and then select the Measurement tab.

1. To program a Measurement type, select Conductivity Select Conductivity, Resistivity, TDS. Salinity or % conc. and press ENTER/MENU.
2. To program the sensor model, select 228 or other toroidal model number and press ENTER/MENU.
3. To program Measurement units, select uS/cm or mS/cm and press ENTER/MENU.
4. To program the Cell constant, enter the exact cell constant value expressed as 3.XXXXX/cm the for the sensor and press ENTER/MENU.
5. To program the Temp Comp method, choose Slope, Neutral Salt, Cation or Raw and press ENTER/MENU.
6. To change the Temperature compensation Slope, enter the linear temperature coefficient expressed as X.XX% / °C and press ENTER/MENU.

The screenshot shows the 'Temperature' tab selected. At the top, it displays 'S1: -54µS/cm 999.9°C' and 'S2: 0.0000GPM'. Below the tabs, the following settings are visible:

- Reference temperature: 25.0 °C
- Filter: 2 sec
- Range: Auto (dropdown)

A 'BACK' button is located at the bottom right.

7. To program the Reference Temperature for Manual temperature compensation (not from probe RTD), enter the Reference temp expressed as XX.X °C and press ENTER/MENU.
8. To Override the default input filter, enter 0-999 seconds and press ENTER/MENU.
9. To program the measurement range, select a specific range appropriate for your process and press ENTER/MENU.

6.6 Chlorine Measurement Programming

With a Chlorine measurement board installed, The 56 can measure any of four variants of Chlorine:

- Free Chlorine
- Total Chlorine
- Monochloramine
- pH-independent Free Chlorine

The section describes how to configure the 56 analyzer for Chlorine measurements.

6.6.1 Free chlorine measurement programming

This Chlorine sub-section describes how to configure the 56 analyzer for Free Chlorine measurement using amperometric chlorine sensors. The following programming and configuration functions are covered:

1. Measure: Free Chlorine Select Free Chlorine, pH Ind. Free Cl. Total Cl, Monochloramine
2. Units: ppm Select units ppm or mg/L
3. Resolution: 0.001 Select display resolution 0.01 or 0.001
4. Free Cl Correct: Live Select Live/Continuous pH correction or Manual
5. Manual pH: 7.00 pH For Manual pH correction, enter the pH value
6. Filter: 5 sec Override the default input filter, enter 0-999 seconds
7. Dual Slope Calibration: Enable or Disable

1. To program the Measurement type, select Free Chlorine, pH Ind Free Cl., Total Cl, or Monochloramine and press ENTER/MENU.
2. To program the Measurement Units: select ppm mg/L and press ENTER/MENU.
3. To program the Measurement Resolution: Select 0.01 or 0.001 and press ENTER/MENU.
4. To program Free Cl Correction, select Live/Continuous pH correction or Manual and press ENTER/MENU

5. To program for Manual pH correction, enter the pH value and press ENTER/MENU.
6. To Override the default input filter, enter 0-999 seconds and press ENTER/MENU.
7. To use Dual Slope Calibration, select Enable or Disable and press ENTER/MENU.

6.6.2 Total chlorine measurement programming

This Chlorine sub-section describes how to configure the 56 analyzer for Total Chlorine measurement using amperometric chlorine sensors. The following programming and configuration functions are covered:

1. Measure: Free Chlorine Select Free Chlorine, pH Ind. Free Cl. Total Cl, Monochloramine
2. Units: ppm Select units ppm or mg/L
3. Resolution: 0.001 Select display resolution 0.01 or 0.001
4. Filter: 5 sec Override the default input filter, enter 0-999 seconds
5. Dual Slope Calibration: Enable or Disable

1. To program the Measurement type, select Free Chlorine, pH Ind Free Cl., Total Cl, or Monochloramine and press ENTER/MENU.
2. To program the Measurement Units: select ppm mg/L and press ENTER/MENU.
3. To program the Measurement Resolution: Select 0.01 or 0.001 and press ENTER/MENU.
4. To Override the default input filter, enter 0-999 seconds and press ENTER/MENU.
5. To use Dual Slope Calibration, select Enable or Disable and press ENTER/MENU.

6.6.3 Monochloramine measurement programming

This Chlorine sub-section describes how to configure the 56 analyzer for Monochloramine measurement using amperometric chlorine sensors. The following programming and configuration functions are covered:

1. Measure: Free Chlorine Select Free Chlorine, pH Ind. Free Cl. Total Cl, Monochloramine
2. Units: ppm Select units ppm or mg/L
3. Resolution: 0.001 Select display resolution 0.01 or 0.001
4. Filter: 5 sec Override the default input filter, enter 0-999 seconds
5. Dual Slope Calibration: Enable or Disable

- To program the Measurement type, select Free Chlorine, pH Ind Free Cl., Total Cl, or Monochloramine and press ENTER/MENU.
- To program the Measurement Units: select ppm mg/L and press ENTER/MENU.
- To program the Measurement Resolution: Select 0.01 or 0.001 and press ENTER/MENU.
- To Override the default input filter, enter 0-999 seconds and press ENTER/MENU.
- To use Dual Slope Calibration, select Enable or Disable and press ENTER/MENU.

6.7 Oxygen Measurement Programming

This section describes how to configure the 56 analyzer for dissolved and gaseous oxygen measurement using amperometric oxygen sensors. The following programming and configuration functions are covered:

- Sensor type: Select Water/Waste, Trace. BioRx, BioRx-Other, Brew, %O₂ In Gas
- Measure type: Select Concentration, % Saturation, Partial Pressure, Oxygen in Gas
- Units: ppm Select ppm, mg/L, ppb, µg/L, % Sat, %O₂-Gas, ppm Oxygen-Gas
- Pressure Units: bar Select pressure units: mm Hg, in Hg., Atm, kPa, mbar, bar
- Use Press: At Air Cal Select atmospheric pressure source – internal or mA Input
- Salinity: 00.0% Enter Salinity as ‰
- Filter: 5 sec Override the default input filter, enter 0-999 seconds
- Partial Press: mmHg Select mm Hg, in Hg. atm, kPa, mbar or bar for Partial pressure

- To program Sensor type, Select Water/Waste, Trace. BioRx, BioRx-Other, Brew, or %O₂ In Gas and press ENTER/MENU.
- To program Measure type: Select Concentration, % Saturation, Partial Pressure, or Oxygen in Gas and press ENTER/MENU.
- To program measurement Units, Select ppm, mg/L, ppb, g/L, % Sat, %O₂-Gas, or ppm Oxygen-Gas and press ENTER/MENU.
- To program Pressure Units: Select pressure units: mm Hg, in Hg., Atm, kPa, mbar, or bar and press ENTER/MENU.

5. To program which atmospheric Pressure source to use during Air Cal, Select internal or mA Input and press ENTER/MENU.
6. To program Salinity, Enter the known Salinity value as ‰ and press ENTER/MENU.
7. To Override the default input filter, enter 0-999 seconds and press ENTER/MENU.
8. To program Partial Press: Select mm Hg, in Hg, atm, kPa, mbar or bar for Partial pressure and press ENTER/MENU.

6.8 Ozone Measurement Programming

This section describes how to configure the 56 analyzer for ozone measurement using amperometric ozone sensors. The following programming and configuration functions are covered:

1. Units: ppm Select ppm, mg/L, ppb, µg/L
2. Resolution: 0.001 Select display resolution 0.01 or 0.001
3. Filter: 5sec Override the default input filter, enter 0-999 seconds

6.9 Oxygen Measurement Programming

1. To program measurement Units, Select ppm, mg/L, ppb, µg/L, % Sat, %O₂-Gas, or ppm Oxygen-Gas and press ENTER/MENU.
2. To program the Measurement Resolution: Select 0.01 or 0.001 and press ENTER/MENU.
3. To Override the default input filter, enter 0-999 seconds and press ENTER/MENU.

6.10 Turbidity Measurement Programming

This section describes how to configure the 56 analyzer for Turbidity measurements. The following programming and configuration functions are covered.

1. Measurement type: Turbidity Select Turbidity or TSS calculation (estimated TSS)
2. Sensor type: Select EPA or ISO
3. Measurement units: NTU, FTU, FNU
4. Filter: 20 sec Override the default input filter, enter 0-999 seconds
5. Bubble Rejection: On Intelligent software algorithm to eliminate erroneous readings caused by bubble accumulation in the sample

S1: 0.002ppm 999.9°C		S2: 0.0000GPM		
Outputs	Relays	Measure	Temperature	Security
		Units	ppm	
		Resolution	0.001	
		Filter	5	sec
				BACK
Warning				

1. To program the Measurement type, Select Turbidity or TSS calculation (estimated TSS) and press ENTER/MENU.
2. To program the Sensor type: Select EPA or ISO and press ENTER/MENU.
3. To program Measurement units: NTU, FTU, FNU and press ENTER/MENU.
4. To Override the default input filter, enter 0-999 seconds and press ENTER/MENU.
5. To program Bubble Rejection, select On or Off and press ENTER/MENU.

The screenshot shows a configuration screen for two sensors, S1 and S2. At the top, S1 is set to '---NTU' and S2 is set to '0.0000GPM'. Below this is a navigation bar with tabs for 'Outputs', 'Relays', 'Measure', and 'Security'. The 'Measure' tab is active. The configuration options are as follows:

- Measurement:** A dropdown menu set to 'Turbidity'.
- Sensor type:** A dropdown menu set to 'EPA'.
- Units:** A dropdown menu set to 'NTU'.
- Bubble rejection:** A dropdown menu set to 'On'.
- Filter:** A text input field containing '20' followed by 'sec'.

At the bottom right, there is a 'BACK' button. A red bar at the very bottom of the screen displays the word 'Fault'.

6.11 Flow Measurement Programming

This section describes how to configure the 56 analyzer for flow measurement when used with a compatible pulse flow sensor. The following programming and configuration functions are covered:

To program pulse flow, scroll to the desired item and press ENTER.

The following sub-sections provide you with the initial display screen that appears for each programming routine.

1. Measurement type Pulse Flow Select Pulse Flow or mA Current Input
2. Measurement units: GPH Select GPM, GPH, cu ft/min, cu ft/hour, LPM, L/hour, m3/hr. or
3. Filter: 5sec Override the default input filter, enter 0-999 seconds

1. To program Measurement type, Select Pulse Flow or mA Current Input and press ENTER/MENU.
2. To program Measurement units: Select GPM, GPH, cu ft/min, cu ft/hour, LPM, L/hour, or m3/hr. and press ENTER/MENU.
3. To Override the default input filter, enter 0-999 seconds and press ENTER/MENU.

6.12 Current Input Programming

This section describes how to configure the 56 analyzer for current input measurement when wired to an external device that transmits 4-20 mA or 0-20 mA analog current output. The following programming and configuration functions are covered.

1. Measurement type mA input Override the default (Flow) and select mA current input
2. mA Input Temperature Select Temperature, Pressure, Flow or Other
3. Measurement units: °C. Select measurement units based on selected input device type
4. Input Range: 4-20 mA Select 4-20 mA or 0-20 mA
5. Low Value: 0.000oC Enter the low measurement value to assign to 4 mA
6. High Value: 100.0oC Enter the high measurement value to assign to 20mA
7. Filter: 05 sec Override the default input filter, enter 0-999 seconds

1. To override the default the Measurement type (Flow) select mA current input and press ENTER/MENU.
2. To program the mA Input type, Select Temperature, Pressure, Flow or other and press ENTER/MENU.
3. To program measurement units, Select measurement units based on selected input device type and press ENTER/MENU.
4. To program the Input Range: Select 4-20 mA or 0-20 mA and press ENTER/MENU.
5. To program the Low input Value, enter the low measurement value to assign to 4mA and press ENTER/MENU.
6. To program the High input Value, enter the high measurement value to assign to 20mA and press ENTER/MENU.
7. To override the default input filter, enter 0-999 seconds and press ENTER/MENU.

S1: --NTU		S2: -25.13mmHg	
Outputs	Relays	Measure	Security
0/4 mA		0.000	mmHg
20 mA		100.5	mmHg
Filter		2	sec

Section 7.0 PID Control

7.1 Introduction

7.1.1 Measurement and Set Point (Feedback Control)

The 56 controller is given two items of information: measurement and set point. The controller reacts to the difference in value of these two signals and produces an analog output signal to eliminate that difference. As long as the difference exists, the controller will try to eliminate it with the output signal. When measurement and set point are equal, the condition of the controller is static and its output is unchanged. Any deviation of measurement from set point will cause the controller to react by changing its output signal.

7.1.2 Proportional Mode

The simplest control is proportional control. In this control function, the error from set point, divided by the control range, is multiplied by the Gain constant to produce the output.

The control range is the percent of the analog output span (the difference between the 4 (or 0) mA and 20 mA settings) through which the measured variable must move to change the output from minimum to maximum.

The smaller the Gain, the less the controller reacts to changes in the measured variable. The larger the Gain, the more the controller reacts to changes in the measured variable.

The proportional control output is given by the expression below. As can be seen, the overall gain is determined by the control range chosen (URV and LRV) and the Gain:

Proportional Output (%) = Gain * (PV - SP) * 100 / (URV - LRV)

7.1.2.1 Direct Acting Control Action

Direct acting control action increases the control output as the measured variable increases above the setpoint. The LRV is usually set to the setpoint value, so that the control output is 0% at the setpoint, and the URV is greater than the setpoint so that the 100% control output is at a higher measurement value. The Gain parameter can then be adjusted to produce the desired gain.

Fig. 7-1 Direct Acting Control

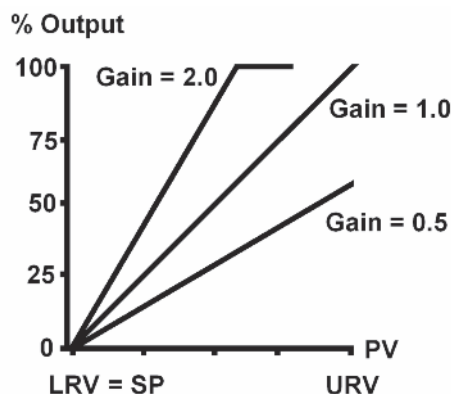

Example of direct acting control: Lower the pH of a solution at 10 pH by adding acid to control it at 8 pH with the Gain parameter assumed to be 1.0. The higher the measured pH, the more acid is required to lower the pH toward the setpoint, but as the pH approaches the setpoint less acid is required:

Fig. 7-2 Example of Direct Acting Control

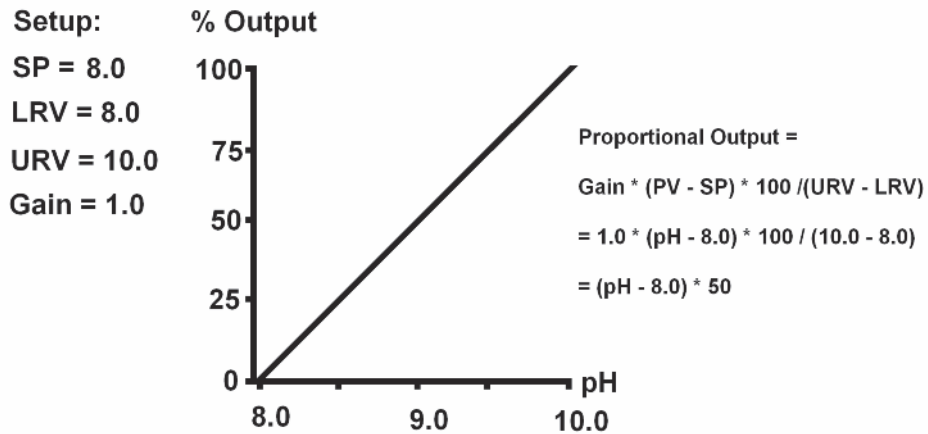

7.1.2.2 Reverse Acting Control Action

Reverse acting control action, decreases the control output as the measured variable increases toward the setpoint. The LRV is usually set to the setpoint value, so that the control output is 0% at the setpoint, and the URV is less than the setpoint value so that the 100% control output is at a lower measurement value. The Gain can then be adjusted to produce the desired gain.

Fig. 7-3 Reverse Acting Control

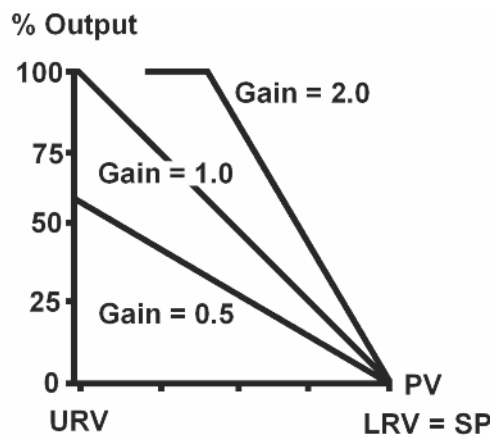

Example of reverse acting control: Add base to a solution at 8.0 pH, to control the pH to 10.0 pH with an assumed Gain parameter of 1.0. The lower the measured pH, the more base is required to raise the pH toward the setpoint, but as the pH approaches the setpoint less base is required:

Fig. 7-4 Example of Reverse Acting Control

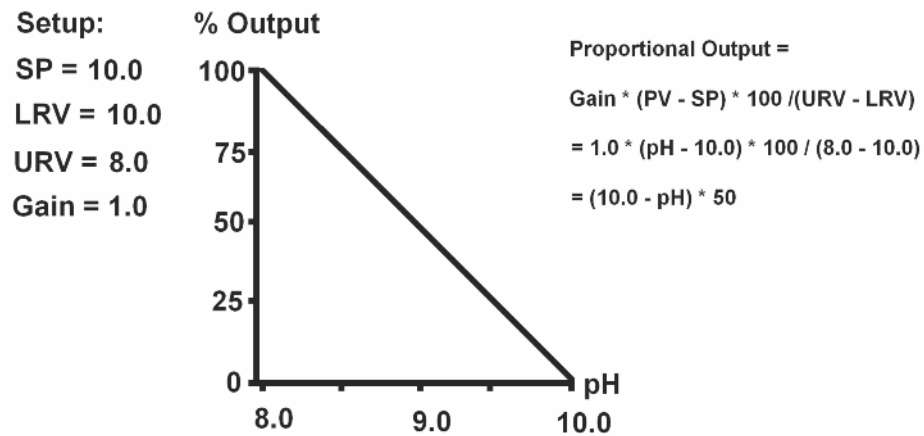

7.1.3 Proportional Bias

Most processes require that the measured variable be held at the set point. The proportional mode alone will not automatically do this, if an output greater than 0% is needed to keep the PV at setpoint. At setpoint, the control output is 0%, and if a non-zero control output is needed to keep the PV at the setpoint, proportional alone will only stabilize the measured variable at some offset (deviation) from the desired setpoint.

Bias is used to provide a constant control output at the setpoint to maintain PV at the setpoint. The effect of Bias is expressed as follows:

$$\text{Proportional Output ()} = [\text{Gain} * (\text{PV} - \text{SP}) * 100 / (\text{URV} - \text{LRV})] + \text{BIAS}$$

Fig. 7-5 Direct Acting Control with Bias

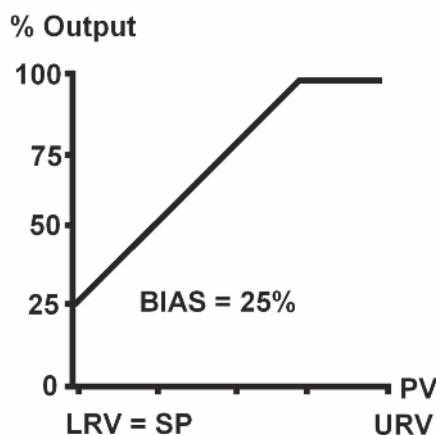
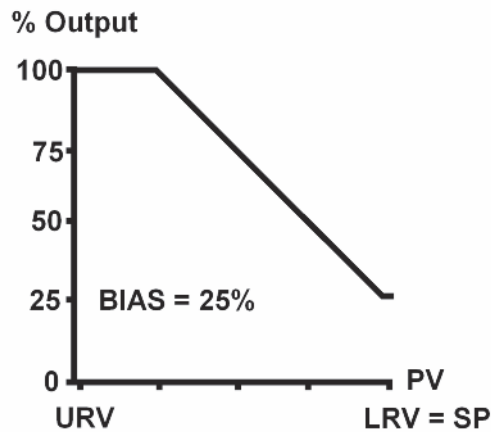

Fig. 7-6 Reverse Acting Control with Bias



7.1.4 Proportional Plus Integral (Reset)

For the automatic elimination of deviation, Integral mode, also referred to as Reset, is used. The proportional function is modified by the addition of automatic reset, rather than a constant Bias value. With the reset mode, the controller continues to change its output until the deviation between measurement and set point is eliminated.

The action of the reset mode depends on the overall gain. The rate at which it changes the controller output is based on the overall gain band size and the reset time (I). The reset time is the time required for the reset mode to repeat the proportional action once. It is expressed as seconds per repeat, adjustable from 0-3,000 seconds.

The reset mode repeats the proportional action as long as an offset from the set point exists. Reset action is cumulative. The longer the offset exists, the more the output signal is increased. If the PV overshoots the setpoint, the reset action will decrease. When the measurement reaches the setpoint and the proportional control action becomes zero, there will be an accumulated integral control action to keep the process at the setpoint.

The controller configured with reset continues to change until there is no offset. If the offset persists, the reset action eventually drives the controller output to its 100% limit - a condition known as "reset windup".

Once the controller is "wound up", the deviation must be eliminated or redirected before the controller can unwind and resume control of the measured variable. The integral time can be cleared and the "windup" condition quickly eliminated by manually overriding the 56 analog output using the manual mode to reduce the control output and then setting the reset time to 0 seconds to make integral control action 0%. The reset time can then be changed to avoid reset windup.

The proportional plus integral control output is given below. Note that the larger the reset time (I), the slower the integral response will be:

$$\text{Output} = [\text{Gain} \times 100 / (\text{URV} - \text{LRV})] \times [(PV - SP) + 1/I \int (PV_t - SP) \Delta t]$$

7.1.5 Derivative Mode (Rate)

Derivative mode provides a 3rd control mode, which responds to the rate of change of the Proportional control output, multiplied by the Derivative parameter D which has units of seconds. The contribution of the derivative response is given below:

$$\text{Output} = [\text{Gain} \times 100 / (\text{URV} - \text{LRV})] \times D \times [(PV_t - SP) - (PV_{t-1} - SP)] / \Delta t$$

The purpose of derivative action is to provide a quick control response to changes in the measured parameter. In general, it is not often used in concentration control, and in fact, it has been estimated that 90 to 95% of all control applications use only Proportional plus Integral control. Any noise in the measurement causes problems with derivative action. Temperature measurements tend to be less noisy than other measurements, and derivative action is most often used for temperature control.

7.1.6 Process Characterization and Tuning

Control loops are tuned by the choice of the control range and the selection of the control parameters. How these parameters are chosen should depend on how the process responds to controller output. The process response is characterized by certain behaviors, which are due to such factors as mixing and reaction time, response time of the process to control output changes, and the characteristics of the final operator, i.e. control valves, pumps, heaters, etc. With these characteristics known, initial control settings can be developed.

A good reference to PID control is provided by the book, “Control Loop Foundation—Batch and Continuous Processes”, by Terrence Blevins and Mark Nixon, International Society of Automation, Research Triangle Park, NC, © 2011.

A guide to tuning control is provided by the book, “Good Tuning: A Pocket Guide”, by Gregory K. McMillan, International Society of Automation, Research Triangle Park, NC, © 2005.

7.2 PID Setup

7.2.1 PID Control

The 56 current –outputs (one or all four) can be programmed for PID control. PID control can be applied to any of the measurements provided by the sensor boards, such as pH, conductivity, and concentrations. In addition, PID control can be applied to temperature and any measurement input to the 56 using the flow/4-20 mA board.

The output signal of PID control is used with a final control element, which can vary is output from 0 to 100% in response to the control signal. Final control elements can include control valves, pumps or heaters.

7.2.2 Selecting PID Control

Select PID control, the analog output to be used, and the measurement and range from the main analog output setup window:

S1: 1.359ppm(f) 77.5°F		S2: 0.051% 77.4°F			
Outputs	Relays	Measure	Temperature	pH diagnostic setup	Security
Output		1			
Analog/PID/Simulate		PID			
Assign		S1 Measurement			
Range		4-20mA			
<input type="button" value="NEXT"/> <input type="button" value="BACK"/>					

Basic Definitions

- Output – Select the analog output (1 through 4) to be configured for PID control.
- Analog/PID/Simulate – Choose PID
- Assign – Select the Measurement to be controlled. Note: This measurement can also be a 4-20 mA signal input brought in by the flow/ 4-20 mA board.
- Range – Select either 0-20 mA or 4-20 mA range, depending on the signal range used by the final control element, e.g. a pump or valve.
- Select Next to go to the PID Setup parameters.

7.2.3 PID Setup Parameters

The PID control setup window contains the PID control tuning parameters.

Also note that the upper portion of the screen shows the measurement chosen for control (PV), and the control output in mA and % Output. This makes it possible to observe the primary variable (PV) and the control output, in terms of percent and milliamps, while tuning PID control.

O1 assign: 1.363ppm		O1: 8.80mA		O1: 30.00%	
Outputs	Relays	Measure	Temperature	pH diagnostic setup	Security
Setpoint		4.000	ppm	Gain	1.00
LRV (0 or 4 mA)		14.00	ppm	Integral (reset)	0 sec
URV (20 mA)		0.000	ppm	Derivative (rate)	0 sec
Bias		10.0	%	Mode	Manual
				Value	30.0 %
<input type="button" value="NEXT"/> <input type="button" value="BACK"/>					

PID Control Parameters: Basic Definitions

- Setpoint – Select the desired setpoint.
- URV – The value of PV (in the above example, 14.00 pH) at which the control will be 20 mA or 100% output.
- LRV -- The value of PV (in the above example 0.00 pH) at which the control will be 0 or 4 mA or 0% output.

Note: If you want the control output to increase as PV (in this case pH) increases, URV should be greater than LRV. This is direct acting control action. Examples of direct acting control are the addition of acid to decrease pH and adding water to a solution to decrease the concentration.

If you want the control output to decrease as PV increases, i.e. reverse acting control action, the URV should be less than LRV. Examples of reverse acting control are adding caustic to increase pH and adding a concentrated solution to water to make a solution of lower concentration.

- **Bias** (range: 0 to 100%; default 0%) – Bias is a fixed control output which allows the control output to be greater than zero when the measurement (PV) is at setpoint. It is used in proportional only control to prevent cycling resulting from the control output going to zero at the setpoint.
- **Gain** (range: 0.0 to 1000.0; default 0.0) – In proportional (P) only control, the output is directly proportional to the difference between the process variable (PV) and the setpoint divided by the output span (URV – LRV). Gain is a factor which multiplies the proportional output to meet the requirements of the process being controlled. Using Gain values less than 1 reduce the proportional output while Gain values greater than 1 increase the proportional output.
- **Integral (Reset, I)** (range: 0 to 3,000 seconds; default 0 seconds) – Integral repeats the proportional action in a time period given by the reset time (I). The reset time is given in seconds per repeat and is adjustable from 0 to 3,000 seconds. Integral control acts as an automatic bias which increases or decreases the overall control output in response to the error (PV – SP) to keep the PV at the setpoint.
- **Derivative (Rate, D)** (range: 0 to 3,000 seconds; default 0 seconds) – Derivative action, gives an immediate control output in response to changes in the proportional output with time (derivative). The amount of increase or decrease depends on the rate of change of the error. The rate constant (D) allows the user to adjust the amount derivative control contributes to the control signal. Smaller values reduce the effect of derivative control.
- **Mode:** Mode has two settings, Auto (Automatic) and Man (Manual). In the Auto mode the control output is controlled automatically by the PID algorithm. In manual mode, the control output can be set to a constant value; this is useful during transmitter calibration or servicing.
- **Value (Manual)** (range: 0 100%) – When the Manual mode is chosen; this control appears on the screen and allows you to write the constant control output value in the Manual mode.

Using the Next button lead to the final PID control window:

7.2.4 Transport Time

Transport Time makes it possible to apply PID control action to a process flowing in a pipe for a short period of time (run time), and then hold the control output fixed to allow the treated sample time to mix and travel to the pH or other analytical sensor (transport time). If properly tuned the PV should reach the setpoint after successive time periods.

It is best used when raw sample pH (or concentration) remains relatively steady for long periods of time, as is the case for samples flowing from a large body of water. It should not be used where process upsets are possible because the delay in applying control will make recovery from the upset slow, and can result in overshoot after the incoming sample has

S1: 1.359ppm(f) 77.6°F		S2: 0.051% 77.4°F			
Outputs	Relays	Measure	Temperature	pH diagnostic setup	Security
Transport time	On	100	sec		
Run time	10	sec			
Fault	Live				

[BACK](#)

Transport Time Parameters: Basic Definitions

- Transport Time (On/Off) – Turns the Transport Time feature on or off.
- Transport Time (range 1 to 600 seconds) – When Transport Time is turned On; a control appears at the right of it, which allows the value of the Transport Time to be enter. This will be the time period that PID control output is held constant, while the treated sample travels to the sensor.
- Run Time (range 0 to 60 seconds) – This is the time period that PID control action is automatic. It always must be a shorter time than Transport Time.

Fault: Basic Definitions

1. Fault – When a measurement fault occurs (either sensor or transmitter) the control output can be setup to continue providing a live control output or the output can be set to a fixed value.

If the live reading is used during a fault condition, the control output could be based on an erroneous measurement, which might cause problems. Using a fixed value for control output during a fault condition can ensure that the control output goes to an acceptable value.

2. Fault Current – If a fixed value on fault is chosen, this parameter selects the output. The control output on fault can be set to a value to prevent a major upset or an unsafe condition.

Note: If a fixed fault current output is chosen and PID control Mode is set to Manual, the Manual output value will override the Fault Current value.

Section 8.0 Time Proportional Control

8.1 Introduction

8.1.1 Time Proportional Control

Time Proportional Control is more commonly known as Duty Cycle or Pulse Width Modulation. It applies PID control to the activation of a relay rather than using an analog output.

The TPC output is defined as the percent of time that a relay is on (% On Time), during a user selected time period (Time Period). As the control output increases the on time increases:

Fig. 8-1 TPC Periods and On Time

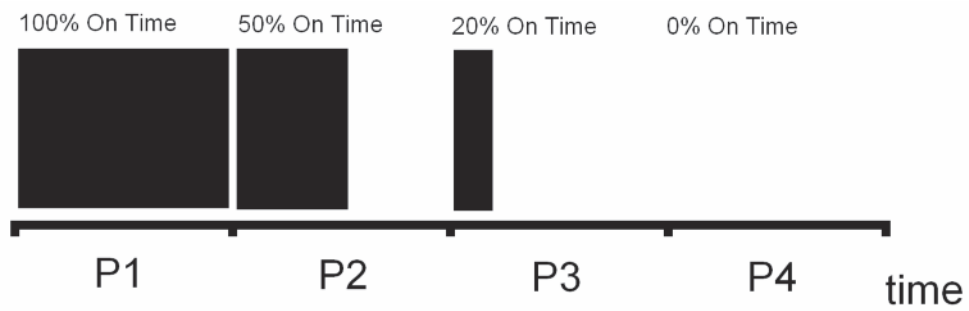

The proportional, integral, and derivative are defined the same as analog PID control, but use % On Time instead of % Output:

$$\text{Proportional On Time ()} = [\text{Gain} \times (\text{PV} - \text{SP}) \times 100 / (\text{URV} - \text{LRV})] + \text{BIAS}$$

Proportional and Integral Control:

$$\text{On Time} = [\text{Gain} \times 100 / (\text{URV} - \text{LRV})] + [(\text{PV} - \text{SP}) + 1/\text{I} (\text{PV}_t - \text{SP}) \Delta t]$$

Derivative Mode:

$$\text{On Time} = [\text{Gain} \times 100 / (\text{URV} - \text{LRV})] \times \text{D} \times [(\text{PV}_t - \text{SP}) - (\text{PV}_{t-1} - \text{SP})] / \Delta t$$

As with analog PID control, TPC can be direct acting (URV > LRV) or reverse acting (LRV > URV). For more detail see Section X.1, PID Control Introduction.

8.2 TPC Setup

8.2.1 Selecting TPC

Select TPC control, the relay to be used, and the measurement to be controlled from the main relay setup window:

S1: 1.358ppm(f) 77.5°F		S2: 0.051% 77.4°F			
Outputs	Relays	Measure	Temperature	pH diagnostic setup	Security
	Relay	1			
	Type	TPC			
	Assign	S1 Measurement			
<input type="button" value="NEXT"/> <input type="button" value="BACK"/>					

Basic Definitions

- Relay – Select the relay (1 through 4) to be use for TPC control.
- Type – Choose TPC
- Assign – Select the Measurement to be controlled. Note: This measurement can also be a 4-20 mA signal input brought in by the flow/ 4-20 mA board.
- Select Next to go to the PID Setup parameters

8.2.2 TPC Setup Parameters

The TPC setup window contains the PID control tuning parameters.

Also note that the upper portion of the screen shows the relay number and the value of the measurement assigned to it, the % On Time for the relay, and the current state of the relay, i.e. On or Off. This makes it possible to observe the primary variable (PV), the % On Time, and the relay state, while tuning time proportional control.

AL1 assign: 1.366ppm		AL1: 30.0%		AL1: On	
Outputs	Relays	Measure	Temperature	pH diagnostic setup	Security
	Setpoint	4.000	ppm	Gain	1.00
	100% on (URV)	14.00	ppm	Integral (reset)	0 sec
	0% on (LRV)	0.000	ppm	Derivative (rate)	0 sec
	Time period	30	sec	Mode	Manual
	Bias	10.0	%	% on time	30.0 %
	Relay default	Close			
<input type="button" value="BACK"/>					

PID Control Parameters: Basic Definitions

- **Setpoint** – Select the desired setpoint.
- **URV** – The value of PV (in the above example, 14.00 pH) at which the control will be 100% On Time.
- **LRV** – The value of PV (in the above example 0.00 pH) at which the control will be 0% On Time.

Note: If you want the control output to increase as PV (in this case pH) increases, URV should be greater than LRV. This is direct acting control action. Examples of direct acting control are the addition of acid to decrease pH and adding water to a solution to decrease the concentration.

If you want the control output to decrease as PV increases, i.e. reverse acting control action, the URV should be less than LRV. Examples of reverse acting control are adding caustic to increase pH and adding a concentrated solution to water to make a solution of lower concentration.

- **Time Period** (range: 10 to 3,000 seconds; default 30) -- The time period for each cycle of TPC.
- **Bias** (range: 0 to 100%; default 0%) – Bias is a fixed control output which allows the % on time to be greater than zero when the measurement (PV) is at setpoint. It is used in proportional only control to prevent cycling resulting from the % on time going to zero at the setpoint.
- **Relay default** (Close, Open, None) – Select the relay action during a fault condition.
- **Gain** (range: 0.0 to 1000.0; default 0.0) – In proportional (P) only control, the output is directly proportional to the difference between the process variable (PV) and the setpoint divided by the output span (URV – LRV). Gain is a factor which multiplies the proportional output to meet the requirements of the process being controlled. Using Gain values less than 1 reduce the proportional output while Gain values greater than 1 increase the proportional output.
- **Integral (Reset, I)** (range: 0 to 3,000 seconds; default 0 seconds) – Integral repeats the proportional action in a time period given by the reset time (I). The reset time is given in seconds per repeat and is adjustable from 0 to 3,000 seconds. Integral control acts as an automatic bias which increases or decreases the overall control output in response to the error (PV – SP) to keep the PV at the setpoint.
- **Derivative (Rate, D)** (range: 0 to 3,000 seconds; default 0 seconds) –Derivative action, gives an immediate control output in response to changes in the proportional output with time (derivative). The amount of increase or decrease depends on the rate of change of the error. The rate constant (D) allows the user to adjust the amount derivative control contributes to the control signal. Smaller values reduce the effect of derivative control.
- **Mode:** Mode has two settings, Auto (Automatic) and Man (Manual). In the Auto mode the control output is controlled automatically by the PID algorithm. In manual mode, the control output can be set to a constant value; this is useful during transmitter calibration or servicing.
- **On Time (Manual)** (range: 0 100%) – When the Manual mode is chosen; this control appears on the screen and allows you to write the constant On Time value in the Manual mode.

Section 9.0 Alarm Relay Functions

9.1 General

An alarm is a relay that closes a set of contact points (a switch) inside the analyzer. In doing so, the relay closes an electrical circuit and turns on a device wired to the contacts. The 56 Advanced Analyzer has four alarm relays and seven relay control functions. The relays are turned on and off by the analyzer based on the control points, setpoints or control parameters that you program into the analyzer through the keypad. See Section 9.2 through 9.7 to program the alarm relay functions. Each relay functions section includes a description, a figure detailing its operation, a step-by-step setup procedure, and a table of default and programmable limit settings.

The 56 has the following relay control functions:

Table 9-1. Alarm Relay Functions

Relay Control Functions	Common applications	Section
High/Low Concentration Alarm	measurement setpoint control	Sec. 9.2
Delay Timer	chemical mixing and neutralization	Sec. 9.3
Bleed and Feed	blowdown and chemical addition	Sec. 9.4
Totalizer Relay Activation	chemical dosing in reactors	Sec. 9.5
Interval Timer	periodic probe cleaning	Sec. 9.6
Date and Time Activation	seawater-cooled condensers	Sec. 9.7

9.2 High/Low Concentration Alarm

9.2.1 Description

High/Low concentration alarms are setpoint alarms with adjustable deadband. These operate as simple on/off alarms used for applications requiring discrete on/off control of pumps and valves. Typical applications include demineralizer bed regeneration and blowdown in boilers and cooling towers. Any active device variable in the 56 analyzer can be programmed as a high/low concentration alarm including the primary or secondary variables, temperature, raw values and diagnostics.

A schematic of the high/low concentration (setpoint) alarm operation is shown below.

Figure 9-1. High/Low Concentration Alarm operation

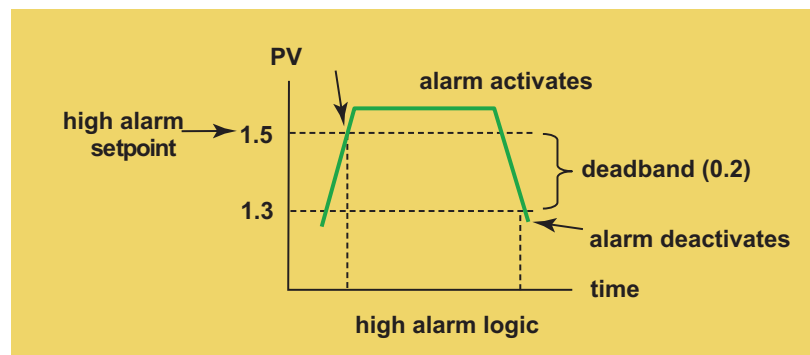

9.2.2 Setup

Access high/low concentration (setpoint) alarms by pressing ENTER/MENU from the main screen and then Program/Relays/Configure Relay. From the main relay programming screen, program this feature as follows:

1. **Relay:** Assign a relay by highlighting the desired relay 1-4 and press ENTER/MENU.
2. **Type:** Select Setpoint as the relay type and press ENTER/MENU.
3. **Assign:** Assign S1 (sensor 1), S2 (sensor 2 if available) or other available parameters to the designated relay and press ENTER/MENU.
4. **Logic:** Set High for a high setpoint or Low for a low setpoint and press ENTER/MENU.
5. **Setpoint:** Enter the desired setpoints value. Press ENTER/MENU.
6. **Deadband:** To set deadband as a measurement value, enter the change in the process value needed after the relay deactivates to return to normal (and thereby preventing repeated alarm activation). Press ENTER/MENU.
7. **Select NEXT.** Press ENTER/MENU to advance to the next setup screen.
8. **Normal state:** Set the normal alarm condition as Open or Closed and press ENTER/MENU. Program the normal state to define the desired alarm default state to normally open or normally closed upon power up.

Table 9-2. Defaults and programmable limits

Relay Function	Limits and Selections	Default
Setpoint	NA	NA
Logic	Low/High	High
Setpoint	*	*
Deadband	*	0.000
On time	0 to 999.9 min	0 min
Delay time	0 to 999.9 min	0 min
Normal state	Close/Open	Open

* See Appendix 1 – HART and Device Variables

9.3 Delay Timer

9.3.1 Description

Delay Timer is a concentration control scheme which delays live measurement after chemical addition using (one or all four of) of the 56 alarm relays. This ensures sufficient mixing time in a vessel or recirculation loop before live sensor measurement, preventing unmixed readings that might cause overshooting. Relay On time and Delay times are field-programmable. Typical applications that would utilize the Delay Timer are: concentration control in vessels, pH adjustments for neutralization and endpoint control for oxidation-reduction reactions.

A schematic of the Delay Timer operation is shown:

Figure 9-2. Delay Timer Alarm operation

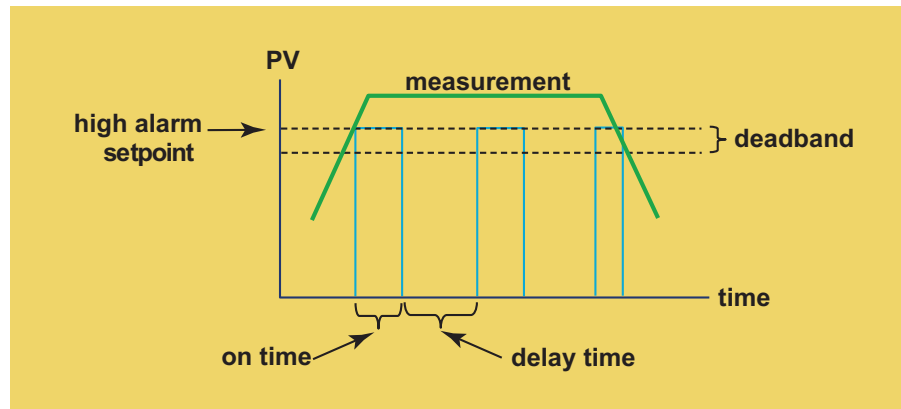

9.3.2 Setup

Access Delay Timer by pressing ENTER/MENU from the main screen and then Program/Relays/Configure Relay. From the main relay programming screen, program this feature as follows:

1. **Relay:** Assign a relay by highlighting the desired relay 1-4 and press ENTER/MENU.
2. **Type:** Select Delay Timer as the relay type and press ENTER/MENU.
3. **Assign:** Assign S1 (sensor 1), S2 (sensor 2 if available) or other available parameters to the designated relay and press ENTER/MENU.
4. **Logic:** Set High for high reading setpoint logic or Low relay logic for low reading setpoint logic and press ENTER/MENU.
5. **Setpoint:** Enter the desired setpoints value. This will activate an alarm event when the process measurement reaches the entered setpoint value. Press ENTER/MENU. See Table 9-2 for entry limits.
6. **Deadband:** To set deadband as a measurement value, enter the change in the process value needed after the relay deactivates to return to normal (and thereby preventing repeated alarm activation). Press ENTER/MENU.
7. **Select NEXT** Press ENTER/MENU to advance to the next setup screen.
8. **On time:** Enter the time in minutes (X.X min) for the relay to remain energized. The assigned measurement value will be on hold during this time.
9. **Delay time:** Enter the time in minutes (X.X min) to take the assigned measurement off hold after the relay is re-energized to begin reporting live values.
10. **Normal state:** Set the normal alarm condition as Open or Closed and press ENTER/MENU. Program the normal state to define the desired alarm default state to normally open or normally closed upon power up.

Table 9-3. Defaults and programmable limits

Relay Function	Limits and Selections	Default
Delay Timer	NA	NA
Logic	Low/High	High
Setpoint	*	*
Deadband	*	0.000
Normal state	Close/Open	Open

* See Appendix 1 – HART and Device Variables

9.4 Bleed and Feed

9.4.1 Description:

A bleed and feed timer is typically used to replace chemicals lost during blowdown. It involves two or more relays. The bleed relay is a normal setpoint alarm relay. Once the bleed relay deactivates, one or more feed relays activate for a percentage of the time the bleed relay was on.

Bleed and Feed supports continuous monitoring of blow-down water conductivity to determine the point of excessive conductivity. At a programmable maximum concentration value, dumping (bleeding) of the excessively dirty blow-down water is triggered. Subsequently, pumping (feeding) of additional make-up water chemicals is enabled to account for lost blow-down water. Through level control, make-up water is added in proportion to the volume of blowdown material lost through dumping and evaporation.

A schematic of the Bleed and Feed timer operation is shown:

Figure 9-3. Bleed and feed timer alarm operation

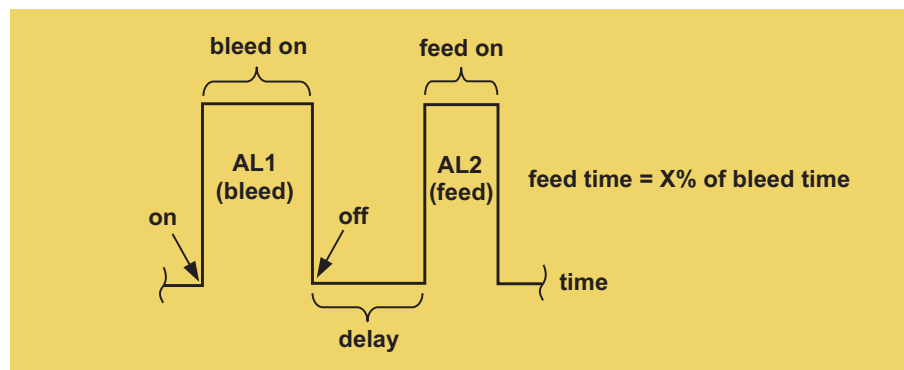

9.4.2 Setup

Access Bleed and Feed Timers by pressing ENTER/MENU from the main screen and then Program/Relays/Configure Relay. From the main relay programming screen, program this feature as follows:

1. Relay: Assign relay 1 for Bleed and Feed and press ENTER/MENU.
2. Type: Select Bleed and Feed as the relay type and press ENTER/MENU.
3. Assign: Assign S1 (sensor 1), S2 (sensor 2 if available) or other available parameters to the designated relay and press ENTER/MENU.
4. Logic: Set High for high setpoint or Low for low setpoint and press ENTER/MENU.

5. **Setpoint:** Enter the desired setpoints value. This will activate an alarm event when the process measurement reaches the entered setpoint value. Press ENTER/MENU. See Table 9-3 for entry limits.
6. Select NEXT Press ENTER/MENU to advance to the next setup screen.
7. **Deadband:** To set deadband as a measurement value, enter the change in the process value needed after the relay deactivates to return to normal (and thereby preventing re-peated alarm activation). Press ENTER/MENU.
8. **Normal state:** Set the normal alarm condition as Open or Closed and press ENTER/MENU. Program the normal state to define the desired alarm default state to normally open or normally closed upon power up.
9. Select NEXT Press ENTER/MENU to advance to the next setup screen: Configure feed relay.
10. **Feed relay:** Assign relay 2, 3, or 4 as a feed relay and press ENTER/MENU.
11. **Linked to bleed relay:** No entry required. The relay originally programmed as the Bleed relay is displayed.
12. **Delay time:** Enter the time in minutes (X.X min) after the Bleed time is activated before triggering this feed relay.
13. **Feed time equals:** Enter the percent of time that the Bleed timer is on (X.X%) to activate this feed relay (for pumping make-up water chemicals).

Relay Function	Limits and Selections	Default
Bleed and Feed	NA	NA
Logic	Low/High	High
Setpoint	*	*
Deadband	*	0.000
Normal state	Close/Open	Open
Feed relay	1, 2, 3, 4	not assigned
Linked to bleed relay	1, 2, 3, 4	1
Delay time	0 - 999.9 min	1.0 min
Feed time equals	0 - 999.9% of bleed time	10.0% of bleed time
Normal state	Close/Open	Open

* See Appendix 1 – HART and Device Variables

9.5 Totalizer Based Relay Activation

9.5.1 Description:

A totalizer based timer feeds chemicals for a preset period every time a programmed volume of liquid has been added to or removed from a vessel. The relay energizes when the volume has been reached and remains energized for a fixed time. The process repeats once the volume has been reached again.

Totalizer Based Relay Activation triggers a relay at user-defined intervals based on accumulated totalized flow. The scheme uses pulse inputs from a flow meter or 4-20mA current input(s) from a flow transmitter to calculate total flow (as volume).

A typical application for totalized flow relay activation is controlling chemical dosing in reactors. A schematic of the Totalizer timer operation is shown:

Figure 9-4. Totalizer alarm operation

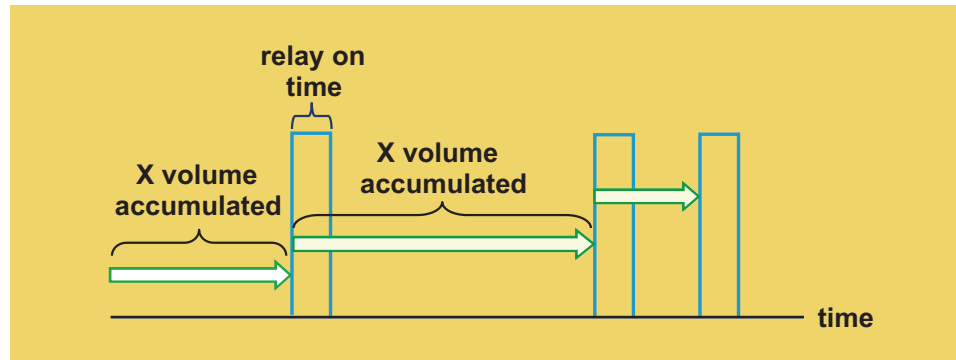

9.5.2 Setup

Access Totalizer Timers by pressing ENTER/MENU from the main screen and then Program/Relays/Configure Relay. From the main relay programming screen, program this feature as follows:

1. **Relay:** Assign a relay by highlighting the desired relay 1-4 and press ENTER/MENU.
2. **Type:** Select Totalizer timer as the relay type and press ENTER/MENU.
3. **Assign:** Assign Pulse flow S1 (sensor 1) or S2 (sensor 2) as the measurement input and press ENTER/MENU.
4. **Active relay after:** Enter accumulated volume (XX.XXXX) and units of measurement (gal, thousand gal, million Gal, trillion Gal).
5. **On time:** Enter the time in minutes (X.X min) for the relay to remain energized. The assigned measurement value will be on hold during this time.
6. **Normal state:** Set the normal alarm condition as Open or Closed and press ENTER/MENU. Program the normal state to define the desired alarm default state to normally open or normally closed upon power up.

Table 9-5. Defaults and programmable limits

Relay Function	Limits and Selections	Default
Totalizer Based Timer	NA	NA
Activate relay after	0 to 99.9990	10
units	Gal, Liters, cuft,m3 accumulated	E3gal (x1000 gal) accumulated
On time	0 to 999.9 min	0 min
Normal state	Close/Open	Open

9.6 Interval Timer

9.6.1 Description:

The interval timer may be used for periodic sensor cleaning or periodic process adjustment. The cycle begins at the Interval time when the switch is turned on. When the Interval time

has expired, the analyzer activates hold mode on the assigned measurement and the relay is energized for the On time period.

A schematic of the Interval timer operation is shown:

Figure 9-5. interval timer Alarm operation

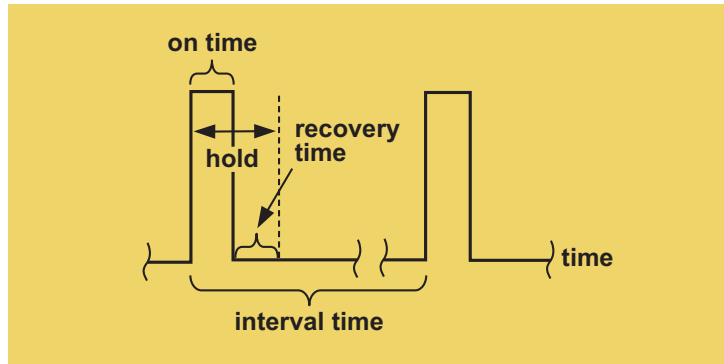

9.6.2 Setup

Access Interval timer by pressing ENTER/MENU from the main screen and then Program/Relays/ Configure Relay. From the main relay programming screen, program this feature as follows:

1. Relay: Assign a relay by highlighting the desired relay 1-4 and press ENTER/MENU.
2. Type: Select Interval timer as the relay type and press ENTER/MENU.
3. Interval time: Enter the time in hours (XX.X hours) between complete interval cycles.
4. On time: Enter the time in minutes (X.X min) for the relay to remain energized. The assigned measurement value will be on hold during this time.
5. Recovery time: Enter the time in minutes (XX min) before the process is restored and live measurements can resume.
6. *Hold while active: Select which sensors outputs should be on hold (S1, S2 or both) during the interval timer activation time. Press ENTER/MENU.
7. Select NEXT Press ENTER/MENU to advance to the next setup screen.
8. Normal state: Set the normal alarm condition as Open or Closed and press ENTER/MENU. Program the normal state to define the desired alarm default state to normally open or normally closed upon power up.

*56 units with software ver. 2.1X and greater allow override of interval timer to ensure that all relays and outputs are held if desired.

Table 9-6. Defaults and programmable limits

Relay Function	Limits and Selections	Default
Interval timer	NA	NA
Interval time	0 to 999.9 hr	24.0 hr
On time	0 to 999.9 sec	10 sec
Recovery time	0 to 999 sec	60 sec
Hold while active	0 to 999 sec	0 sec
Normal state	Sensor 1, Sensor 1, both	Sensor 1

9.7 Date and Time Activation

9.7.1 Description:

This relay feature allows programming of 1 to 4 relays to activate on an assigned day of the week and time of day or night for an assigned interval. They function like sprinkler timers. The programmable timeframe cycle is two weeks.

An example application for Date and Time Activation is daily chlorine dosing in seawater-cooled condensers.

The Date and Time relay setup screen is shown:

Figure 9-6. Date and Time alarm operation

Live display

Outputs Relays Measure Temperature pH diagnostic setup Security

Enter duration in minutes.

Week 1	Sun	Mon	Tues	Wed	Thurs	Fri	Sat
Start	<input type="text"/> hh	<input type="text"/> hh	<input type="text"/> hh	<input type="text"/> hh	<input type="text"/> hh	<input type="text"/> hh	<input type="text"/> hh
	<input type="text"/> mm	<input type="text"/> mm	<input type="text"/> mm	<input type="text"/> mm	<input type="text"/> mm	<input type="text"/> mm	<input type="text"/> mm
Duration	<input type="text"/>	<input type="text"/>	<input type="text"/>	<input type="text"/>	<input type="text"/>	<input type="text"/>	<input type="text"/>

NEXT BACK

Fault/warning banner

9.7.2 Setup

Access Date and Time timer by pressing ENTER/MENU from the main screen and then Program/Relays/Configure Relay. From the main relay programming screen, program this feature as follows:

1. Relay: Assign a relay by highlighting the desired relay 1-4 and press ENTER/MENU.
2. Type: Select Date and time timer as the relay type and press ENTER/MENU.
3. Select NEXT Press ENTER/MENU to advance to the next setup screen.
4. The Week 1 calendar will appear. Program the start relay activate time by entering day(s) of week, hour(s) of day and minutes for each hour. Enter the duration of time in minutes (XX min) for relay activation. Up to four relays can be simultaneously energized for any programmed times
5. Select NEXT Press ENTER/MENU to advance to the next setup screen.
6. The Week 2 calendar will appear. Repeat the programming entries for week 2 in the same manner as week 1. Up to four relays can be simultaneously energized for any programmed times.

⚠ CAUTION

Date and Time timer operation depends on accurate setup of the internal real time clock. Continuous powered operation of the 56 analyzer is recommended to preserve programmed Date and Time timer clock settings.

Section 10.0 Calibration

10.1 Calibration – Introduction

Calibration is the process of adjusting or standardizing the analyzer to a lab test or a calibrated laboratory instrument, or standardizing to some known reference (such as a commercial buffer). The auto-recognition feature of the analyzer will enable the appropriate calibration screens to allow calibration for any single sensor configuration or dual sensor configuration of the analyzer. Completion of Quick Start upon first power up enables live measurements but does not ensure accurate readings in the lab or in process. Calibration should be performed with each attached sensor to ensure accurate, repeatable readings. This section covers the following programming and configuration functions:

1. Auto buffer cal for pH (pH Cal - Sec.7.2)
2. Manual buffer cal for pH (pH Cal - Sec.7.2)
3. Set calibration stabilization criteria for pH (pH Cal - Sec.7.2)
4. Standardization calibration (1-point) for pH, ORP and Redox (pH Cal - Sec.7.2 and 7.3)
5. Entering the cell constant of a conductivity sensor (Conductivity Cal - Sec. 7.4 and 7.5)
6. Calibrating the sensor in a conductivity standard Conductivity Cal - Sec. 7.4 and 7.5)
7. Calibrating the analyzer to a laboratory instrument (Contacting Conductivity Cal - Sec.7.4)
8. Zeroing an chlorine, oxygen or ozone sensor (Amperometric Cal - Sec's 7.6, 7.7, 7.8)
9. Calibrating an oxygen sensor in air (Oxygen Cal - Sec's 7.6)
10. Calibrating the sensor to a sample of known concentration (Amperometric Cal - Sec's 7.6, 7.7, 7.8)
11. Enter a manual reference temperature for temperature compensation of the process measurement

10.2 pH Calibration

New sensors must be calibrated before use. Regular recalibration is also necessary. Use auto calibration instead of manual calibration. Auto calibration avoids common pitfalls and reduces errors. The analyzer recognizes the buffers and uses temperature-corrected pH values in the calibration. Once the 56 successfully completes the calibration, it calculates and displays the calibration slope and offset. The slope is reported as the slope at 25 °C.

To calibrate the pH loop with a connected pH sensor, access the Calibration screen by pressing ENTER/MENU from the main screen, select S1 or S2 Measurement and press ENTER/MENU. Press INFO at any time to learn more about this procedure. A yellow screen will appear with detailed instructions and information.

The following calibration routines are covered:

1. Auto Calibration - pH 2 point buffer calibration with auto buffer recognition
2. Manual Calibration - pH 2 point buffer calibration with manual buffer value entry
3. Standardization - pH 1 point buffer calibration with manual buffer value entry

S1: 7.00pH 25.2°C		S2: 0.056 µS/cm 52.1°C	
Calibrate what?			
<input checked="" type="checkbox"/> S1 Measurement	<input type="checkbox"/> S1 Temperature	<input type="checkbox"/> Output 1	<input type="checkbox"/> Output 2
<input type="checkbox"/> S2 Measurement	<input type="checkbox"/> S2 Temperature	<input type="checkbox"/> Output 3	<input type="checkbox"/> Output 4
<input type="button" value="BACK"/>			

4. Entering A Known Slope Value - pH Slope calibration with manual entry of known slope value
1. To Auto Calibrate the pH loop using 2 point buffer calibration with auto buffer recognition, select Auto Buffer and follow the step-by-step procedures displayed on-screen.
2. To Manual Calibrate the pH loop using 2 point buffer calibration with manual buffer value entry, select Manual Buffer and follow the step-by-step procedures displayed on-screen.
3. To Standardization Calibrate the pH loop using 1 point buffer calibration with manual buffer value entry, select Standardize and follow the step-by-step procedures displayed on-screen.
4. To Calibrate the pH loop using with manual entry of a Known Slope Value and Reference offset value, select Slope/Offset and follow the step-by-step procedures displayed on-screen.

S1: 0.031µS/cm 999.9°C S2: -25.14mmHg

Why is calibration necessary? To find out, press INFO. Otherwise, choose the desired calibration method.

Auto buffer	Slope/offset
Manual buffer	
Standardize (grab)	
Standardize (in process)	

BACK

10.3 ORP Calibration

For process control, it is often important to make the measured ORP agree with the ORP of a standard solution. During calibration, the measured ORP is made equal to the ORP of a standard solution at a single point.

To calibrate the ORP loop with a connected ORP sensor, access the Calibration screen by pressing ENTER/MENU from the main screen, select S1 or S2 Measurement and press ENTER/MENU. Press INFO at any time to learn more about this procedure. A yellow screen will appear with detailed instructions and information.

The following calibration routine is covered:

1. To Standardization the ORP loop using 1 point buffer calibration with manual buffer value entry, follow the step-by-step procedures displayed on-screen.

S1: 7.00pH 25.2°C S2: 0.056 µS/cm 52.1°C

Calibrate what?

S1 Measurement	Output 1
S1 Temperature	Output 2
S2 Measurement	Output 3
S2 Temperature	Output 4

BACK

S1: 0mV 999.9°C S2: -25.14mmHg

Why is calibration necessary? To find out, press INFO. Otherwise, press ENTER.

BACK

Warning

10.4 Contacting Conductivity Calibration

New conductivity sensors rarely need calibration. The cell constant printed on the label is sufficiently accurate for most applications.

CALIBRATING AN IN-SERVICE CONDUCTIVITY SENSOR

After a conductivity sensor has been in service for a period of time, recalibration may be necessary. There are three ways to calibrate a sensor.

- a. Use a standard instrument and sensor to measure the conductivity of the process stream. It is not necessary to remove the sensor from the process piping. The temperature correction used by the standard instrument may not exactly match the temperature correction used by the 56. To avoid errors, turn off temperature correction in both the analyzer and the standard instrument.
- b. Place the sensor in a solution of known conductivity and make the analyzer reading match the conductivity of the standard solution. Use this method if the sensor can be easily removed from the process piping and a standard is available. Be careful using standard solutions having conductivity less than 100 $\mu\text{S}/\text{cm}$. Low conductivity standards are highly susceptible to atmospheric contamination. Avoid calibrating sensors with 0.01/cm cell constants against conductivity standards having conductivity greater than 100 $\mu\text{S}/\text{cm}$. The resistance of these solutions may be too low for an accurate measurement. Calibrate sensors with 0.01/cm cell constant using method c.
- c. To calibrate a 0.01/cm sensor, check it against a standard instrument and 0.01/cm sensor while both sensors are measuring water having a conductivity between 5 and 10 $\mu\text{S}/\text{cm}$. To avoid drift caused by absorption of atmospheric carbon dioxide, saturate the sample with air before making the measurements. To ensure adequate flow past the sensor during calibration, take the sample downstream from the sensor. For best results, use a flow-through standard cell. If the process temperature is much different from ambient, keep connecting lines short and insulate the flow cell.

To calibrate the conductivity loop with a connected contacting conductivity sensor, access the Calibration screen by pressing ENTER/MENU from the main screen, select S1 or S2 Measurement and press ENTER/MENU. Press INFO at any time to learn more about this procedure. A yellow screen will appear with detailed instructions and information.

The following calibration routines are covered:

1. Zero Cal Zero the analyzer with the sensor attached
2. In Process Cal Standardize the sensor to a known conductivity
3. Cell K: 1.00000/cm Enter the cell Constant for the sensor
4. Meter Cal Calibrate the analyzer to a lab conductivity instrument
5. Cal Factor: 0.95000/cm Enter the Cal Factor for 4-Electrode sensors from the sensor tag

S1: 7.00pH 25.2°C		S2: 0.056 $\mu\text{S}/\text{cm}$ 52.1°C	
Calibrate what?			
<input checked="" type="checkbox"/> S1 Measurement	<input type="checkbox"/> S1 Temperature	<input type="checkbox"/> Output 1	<input type="checkbox"/> Output 2
<input type="checkbox"/> S2 Measurement	<input type="checkbox"/> S2 Temperature	<input type="checkbox"/> Output 3	<input type="checkbox"/> Output 4
<input type="button" value="BACK"/>			

1. To Zero Calibrate the analyzer with the sensor attached, follow the step-by-step procedures displayed on-screen.
2. To perform an In-Process Calibration of the conductivity loop by Standardizing the sensor to a known conductivity, follow the step-by-step procedures displayed on-screen.
3. To calibrate the conductivity loop by entering a Cell constant, Enter the cell Constant for the sensor and follow the step-by-step procedures displayed on-screen.
4. To Meter Cal Calibrate the analyzer to a lab conductivity instrument, follow the step-by-step procedures displayed on-screen.
5. To enter the Cal Factor to support calibration of a 4-Electrode sensors, enter the Cal Factor for the 4-Electrode sensors from the sensor tag and follow the step-by-step procedures displayed on-screen.

S1: 0.031 μ S/cm 999.9°C S2: -25.14mmHg

Why is calibration necessary? To find out, press INFO. Otherwise, choose the desired calibration method.

Zero	Cell constant
Standard solution	Meter
In process	
Grab sample	

BACK

Warning

10.5 Toroidal Conductivity Calibration

Calibration is the process of adjusting or standardizing the analyzer to a lab test or a calibrated laboratory instrument, or standardizing to some known reference (such as a conductivity standard). This section contains procedures for the first time use and for routine calibration of the 56 analyzer.

To calibrate the conductivity loop with a connected contacting conductivity sensor, access the Calibration screen by pressing ENTER/MENU from the main screen, select S1 or S2 Measurement and press ENTER/MENU. Press INFO at any time to learn more about this procedure. A yellow screen will appear with detailed instructions and information.

The following calibration routines are covered:

1. Zero Cal Zero the analyzer with the sensor attached
 2. In Process Cal Standardize the sensor to a known conductivity
 3. Cell K: 1.00000/cm Enter the cell Constant for the sensor
1. To Zero Calibrate the analyzer with the sensor attached, follow the step-by-step procedures displayed on-screen.
 2. To perform an In-Process Calibration of the conductivity loop by Standardizing the sensor to a known conductivity, follow the step-by-step procedures displayed on-screen.
 3. To calibrate the conductivity loop by entering a Cell constant, Enter the cell Constant for the sensor and follow the step-by-step procedures displayed on-screen.

S1: 7.00pH 25.2°C S2: 0.056 μ S/cm 52.1°C

Calibrate what?

S1 Measurement	Output 1
S1 Temperature	Output 2
S2 Measurement	Output 3
S2 Temperature	Output 4

BACK

S1: -53 μ S/cm 999.9°C

Why is calibration necessary? To find out, press INFO. Otherwise, choose the desired calibration method.

Zero	Cell constant
Standard solution	
In process	
Grab sample	

BACK

10.6 Calibration—Chlorine

With a Chlorine measurement board and the appropriate sensor, the 56 can measure any of four variants of Chlorine:

- Free Chlorine
- Total Chlorine
- Monochloramine
- pH-independent Free Chlorine

The section describes how to calibrate any compatible amperometric chlorine sensor. The following calibration routines are covered in the family of supported Chlorine sensors:

- Air Cal
- Zero Cal
- In Process Cal

10.6.1 Calibration—Free Chlorine

A free chlorine sensor generates a current directly proportional to the concentration of free chlorine in the sample. Calibrating the sensor requires exposing it to a solution containing no chlorine (zero standard) and to a solution containing a known amount of chlorine (full-scale standard). The zero calibration is necessary because chlorine sensors, even when no chlorine is in the sample, generate a small current called the residual current. The analyzer compensates for the residual current by subtracting it from the measured current before converting the result to a chlorine value. New sensors require zeroing before being placed in service, and sensors should be zeroed whenever the electrolyte solution is replaced.

To calibrate the chlorine sensor, access the Calibration screen by pressing ENTER/MENU from the main screen, select S1 or S2 Measurement and press ENTER/MENU. Press INFO at any time to learn more about this procedure. A yellow screen will appear with detailed instructions and information.

The following calibration routines are covered:

1. Zero Cal Zeroing the sensor in solution with zero free chlorine
 2. Grab Cal Standardizing to a sample of known free chlorine concentration
1. To Zero Calibrate the analyzer with the sensor attached, follow the step-by-step procedures displayed on-screen.
 2. To perform a Grab Calibration by Standardizing the sensor, follow the step-by-step procedures displayed on-screen.

S1: 7.00pH 25.2°C S2: 0.056 µS/cm 52.1°C

Calibrate what?

S1 Measurement	Output 1
S1 Temperature	Output 2
S2 Measurement	Output 3
S2 Temperature	Output 4

BACK

S1:-53µS/cm 999.9°C S2:-0.447ppm 999.9°C

Why is calibration necessary? To find out, press INFO. Otherwise, choose the desired calibration method.

Zero
Grab

BACK

10.6.2 Calibration – Total Chlorine

Total chlorine is the sum of free and combined chlorine. The continuous determination of total chlorine requires two steps. First, the sample flows into a conditioning system (TCL) where a pump continuously adds acetic acid and potassium iodide to the sample. The acid lowers the pH, which allows total chlorine in the sample to quantitatively oxidize the iodide in the reagent to iodine. In the second step, the treated sample flows to the sensor. The sensor is a membrane-covered amperometric sensor, whose output is proportional to the concentration of iodine.

Because the concentration of iodine is proportional to the concentration of total chlorine, the analyzer can be calibrated to read total chlorine. Because the sensor really measures iodine, calibrating the sensor requires exposing it to a solution containing no iodine (zero standard) and to a solution containing a known amount of iodine (full-scale standard). The Zero calibration is necessary because the sensor, even when no iodine is present, generates a small current called the residual current. The analyzer compensates for the residual current by subtracting it from the measured current before converting the result to a total chlorine value. New sensors require zeroing before being placed in service, and sensors should be zeroed whenever the electrolyte solution is replaced. The best zero standard is deionized water. The purpose of the In Process Calibration is to establish the slope of the calibration curve. Because stable total chlorine standards do not exist, the sensor must be calibrated against a test run on a grab sample of the process liquid. Several manufacturers offer portable test kits for this purpose.

To calibrate the chlorine sensor, access the Calibration screen by pressing ENTER/MENU from the main screen, select S1 or S2 Measurement and press ENTER/MENU. Press INFO at any time to learn more about this procedure. A yellow screen will appear with detailed instructions and information.

The following calibration routines are covered:

1. Zero Cal Zeroing the sensor in solution with zero total chlorine
2. Grab Cal Standardizing to a sample of known total chlorine concentration

S1: 7.00pH 25.2°C S2: 0.056 µS/cm 52.1°C

Calibrate what?

S1 Measurement	Output 1
S1 Temperature	Output 2
S2 Measurement	Output 3
S2 Temperature	Output 4

BACK

1. To Zero Calibrate the analyzer with the sensor attached, follow the step-by-step procedures displayed on-screen.
2. To perform a Grab Calibration by Standardizing the sensor, follow the step-by-step procedures displayed on-screen.

S1:-53µS/cm 999.9°C S2:-0.447ppm 999.9°C

Why is calibration necessary? To find out, press INFO. Otherwise, choose the desired calibration method.

Zero
Grab

BACK

10.6.3 Calibration – Monochloramine

A monochloramine sensor generates a current directly proportional to the concentration of monochloramine in the sample. Calibrating the sensor requires exposing it to a solution containing no monochloramine (zero standard) and to a solution containing a known amount of monochloramine (full-scale standard). The Zero calibration is necessary because monochloramine sensors, even when no monochloramine is in the sample, generate a small current called the residual or zero current. The analyzer compensates for the residual current by subtracting it from the measured current before converting the result to a monochloramine value. New sensors require zeroing before being placed in service, and sensors should be zeroed whenever the electrolyte solution is replaced. The best zero standard is deionized water.

The purpose of the In Process calibration is to establish the slope of the calibration curve. Because stable monochloramine standards do not exist, the sensor must be calibrated against a test run on a grab sample of the process liquid. Several manufacturers offer portable test kits for this purpose.

To calibrate the chlorine sensor, access the Calibration screen by pressing ENTER/MENU from the main screen, select S1 or S2 Measurement and press ENTER/MENU. Press INFO at any time to learn more about this procedure. A yellow screen will appear with detailed instructions and information.

The following calibration routines are covered:

1. Zero Cal Zeroing the sensor in solution with zero total chlorine
2. Grab Cal Standardizing to a sample of known monochloramine concentration

1. To Zero Calibrate the analyzer with the sensor attached, follow the step-by-step procedures displayed on-screen.
2. To perform a Grab Calibration by Standardizing the sensor, follow the step-by-step procedures displayed on-screen.

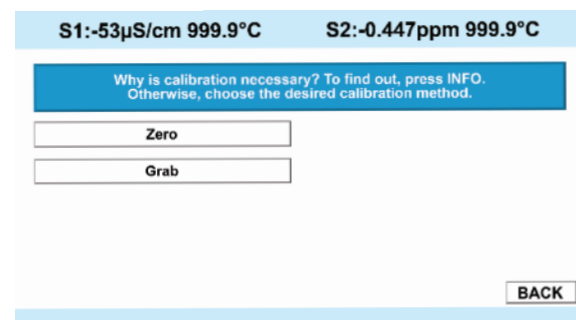
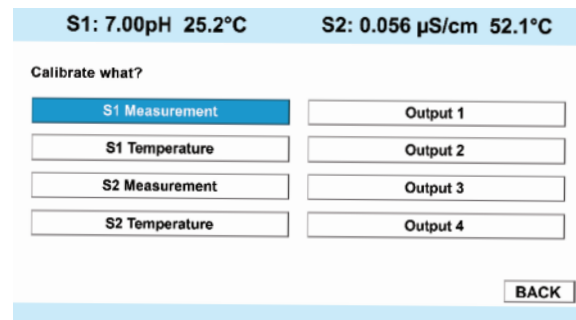

10.6.4 pH-Independent Free Chlorine Measurement

A free chlorine sensor generates a current directly proportional to the concentration of free chlorine in the sample. Calibrating the sensor requires exposing it to a solution containing no chlorine (zero standard) and to a solution containing a known amount of chlorine (full-scale

standard). The zero calibration is necessary because chlorine sensors, even when no chlorine is in the sample, generate a small current called the residual current. The analyzer compensates for the residual current by subtracting it from the measured current before converting the result to a chlorine value. New sensors require zeroing before being placed in service, and sensors should be zeroed whenever the electrolyte solution is replaced.

To calibrate the chlorine sensor, access the Calibration screen by pressing ENTER/MENU from the main screen, select S1 or S2 Measurement and press ENTER/MENU. Press INFO at any time to learn more about this procedure. A yellow screen will appear with detailed instructions and information.

The following calibration routines are covered:

1. Zero Cal Zeroing the sensor in solution with zero total chlorine
2. Grab Cal Standardizing to a sample of known chlorine concentration

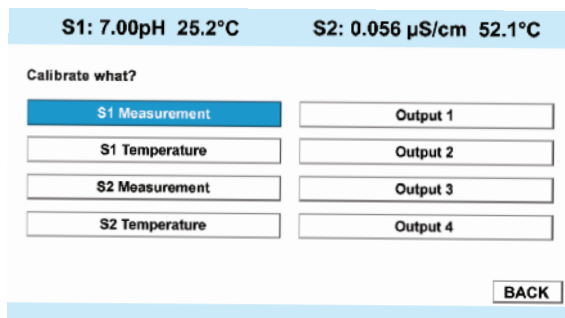

1. To Zero Calibrate the analyzer with the sensor attached, follow the step-by-step procedures displayed on-screen.
2. To perform a Grab Calibration by Standardizing the sensor, follow the step-by-step procedures displayed on-screen.

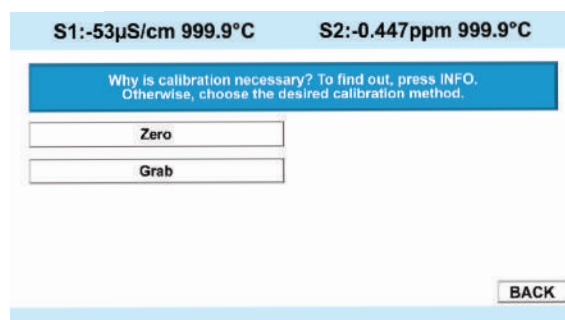

10.7 Calibration — Oxygen

Oxygen sensors generate a current directly proportional to the concentration of dissolved oxygen in the sample. Calibrating the sensor requires exposing it to a solution containing no oxygen (zero standard) and to a solution containing a known amount of oxygen (full-scale standard). The Zero Calibration is necessary because oxygen sensors, even when no oxygen is present in the sample, generate a small current called the residual current. The analyzer compensates for the residual current by subtracting it from the measured current before converting the result to a dissolved oxygen value. New sensors require zeroing before being placed in service, and sensors should be zeroed whenever the electrolyte solution is replaced. The recommended zero standard is 5% sodium sulfite in water, although oxygen-free nitrogen can also be used. The 499A TrDO sensor, used for the determination of trace (ppb) oxygen levels, has very low residual current and does not normally require zeroing. The residual current in the 499A TrDO sensor is equivalent to less than 0.5 ppb oxygen. The purpose of the In Process Calibration is to establish the slope of the calibration curve. Because the solubility of atmospheric oxygen in water as a function of temperature and barometric pressure is well known, the natural choice for a full-scale standard is air-saturated water. However, air-saturated water is difficult to prepare and use, so the universal practice is to use air for calibration. From the point of view of the oxygen sensor, air and air-saturated water are identical. The equivalence

comes about because the sensor really measures the chemical potential of oxygen. Chemical potential is the force that causes oxygen molecules to diffuse from the sample into the sensor where they can be measured. It is also the force that causes oxygen molecules in air to dissolve in water and to continue to dissolve until the water is saturated with oxygen. Once the water is saturated, the chemical potential of oxygen in the two phases (air and water) is the same. Oxygen sensors generate a current directly proportional to the rate at which oxygen molecules diffuse through a membrane stretched over the end of the sensor. The diffusion rate depends on the difference in chemical potential between oxygen in the sensor and oxygen in the sample.

An electrochemical reaction, which destroys any oxygen molecules entering the sensor, keeps the concentration (and the chemical potential) of oxygen inside the sensor equal to zero. Therefore, the chemical potential of oxygen in the sample alone determines the diffusion rate and the sensor current. When the sensor is calibrated, the chemical potential of oxygen in the standard determines the sensor current. Whether the sensor is calibrated in air or air-saturated water is immaterial. The chemical potential of oxygen is the same in either phase. Normally, to make the calculation of solubility in common units (like ppm DO) simpler, it is convenient to use water-saturated air for calibration. Automatic air calibration is standard. The user simply exposes the sensor to water-saturated air. The analyzer monitors the sensor current. When the current is stable, the analyzer stores the current and measures the temperature using a temperature element inside the oxygen sensor. The user must enter the barometric pressure. From the temperature the analyzer calculates the saturation vapor pressure of water. Next, it calculates the pressure of dry air by subtracting the vapor pressure from the barometric pressure. Using the fact that dry air always contains 20.95% oxygen, the analyzer calculates the partial pressure of oxygen. Once the analyzer knows the partial pressure of oxygen, it uses the Bunsen coefficient to calculate the equilibrium solubility of atmospheric oxygen in water at the prevailing temperature. At 25 °C and 760 mmHg, the equilibrium solubility is 8.24 ppm. Often it is too difficult or messy to remove the sensor from the process liquid for calibration. In this case, the sensor can be calibrated against a measurement made with a portable laboratory instrument. The laboratory instrument typically uses a membrane-covered amperometric sensor that has been calibrated against water-saturated air.

To calibrate the oxygen sensor, access the Calibration screen by pressing ENTER/MENU from the main screen, select S1 or S2 Measurement and press ENTER/MENU. Press INFO at any time to learn more about this procedure. A yellow screen will appear with detailed instructions and information.

The following calibration routines are covered:

1. Zero Cal Zeroing the sensor in a medium with zero oxygen
2. Air Cal Calibrating the sensor in a water-saturated air sample
3. In Process Cal Standardizing to a sample of known oxygen concentration
4. Sen@ 25 °C:2500 µA/ppm Entering a known slope value for sensor response.

S1: 7.00pH 25.2°C		S2: 0.056 µS/cm 52.1°C	
Calibrate what?			
S1 Measurement	Output 1	Output 2	Output 3
S1 Temperature	Output 4	Output 5	Output 6
S2 Measurement	Output 7	Output 8	Output 9
S2 Temperature	Output 10	Output 11	Output 12
BACK			

1. To Zero Calibrate the analyzer with the sensor attached, follow the step-by-step procedures displayed on-screen.

2. To Air Cal Calibrating the sensor in a water-saturated air sample, follow the step-by-step procedures displayed on-screen.
3. To perform an In-Process Calibration by Standardizing the sensor, follow the step-by-step procedures displayed on-screen.
4. To calibrate the oxygen sensor by manually Entering a known slope value for sensor response, follow the step-by-step procedures displayed on-screen.

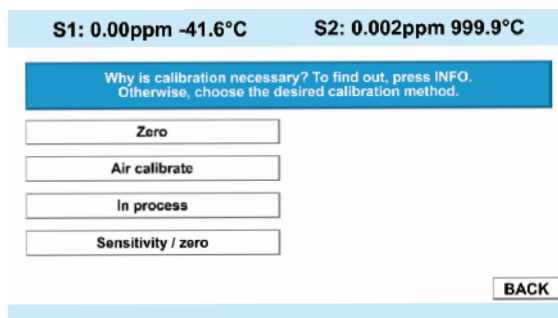

10.8 Calibration – Ozone

An ozone sensor generates a current directly proportional to the concentration of ozone in the sample. Calibrating the sensor requires exposing it to a solution containing no ozone (zero standard) and to a solution containing a known amount of ozone (full-scale standard). The Zero Calibration is necessary because ozone sensors, even when no ozone is in the sample, generate a small current called the residual or zero current. The analyzer compensates for the residual current by subtracting it from the measured current before converting the result to an ozone value. New sensors require zeroing before being placed in service, and sensors should be zeroed whenever the electrolyte solution is replaced. The best zero standard is deionized water. The purpose of the In Process Calibration is to establish the slope of the calibration curve. Because stable ozone standards do not exist, the sensor must be calibrated against a test run on a grab sample of the process liquid. Several manufacturers offer portable test kits for this purpose.

To calibrate the ozone sensor, access the Calibration screen by pressing ENTER/MENU from the main screen, select S1 or S2 Measurement and press ENTER/MENU. Press INFO at any time to learn more about this procedure. A yellow screen will appear with detailed instructions and information.

The following calibration routines are covered:

1. Zero Cal Zeroing the sensor in solution with zero total chlorine
 2. Grab Cal Standardizing to a sample of known ozone concentration
1. To Zero Calibrate the analyzer with the sensor attached, follow the step-by-step procedures displayed on-screen.
 2. To perform a Grab Calibration by Standardizing the sensor, follow the step-by-step procedures displayed on-screen.

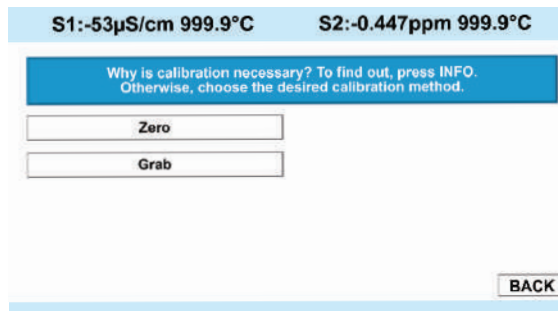
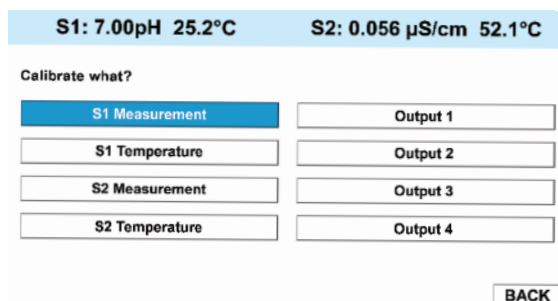

10.9 Calibrating Temperature

Most liquid analytical measurements require temperature compensation (except ORP). The 56 performs temperature compensation automatically by applying internal temperature correction algorithms. Temperature correction can also be turned off. If temperature correction is off, the 56 uses the manual temperature entered by the user in all temperature correction calculations.

To calibrate temperature, access the Calibration screen by pressing ENTER/MENU from the main screen, select S1 or S2 Temperature and press ENTER/MENU. Press INFO at any time to learn more about this procedure. A yellow screen will appear with detailed instructions and information.

The following calibration routine is covered:

1. Temperature with manual temperature entry
2. To Calibrate Temperature, follow the step-by-step procedures displayed on-screen.

The screenshot shows the calibration interface with the following elements:

- Header: **S1: 7.00pH 25.2°C** **S2: 0.056 μ S/cm 52.1°C**
- Section: **Calibrate what?**
- Buttons:

S1 Measurement	Output 1
S1 Temperature	Output 2
S2 Measurement	Output 3
S2 Temperature	Output 4
- Bottom right: **BACK**

A second screenshot below shows a message box:

- Header: **S1: 0.00ppm -41.6°C** **S2: 0.002ppm 999.9°C**
- Message box: **Why is calibration necessary?**
To find out, press INFO. Otherwise, press ENTER.
- Bottom right: **BACK**

10.10 Turbidity

This section describes how to calibrate the turbidity sensor against a user-prepared standard as a 2-point calibration with deionized water, against a 20 NTU user-prepared standard as a single point calibration, and against a grab sample using a reference turbidimeter.

To calibrate the turbidity sensor, access the Calibration screen by pressing ENTER/MENU from the main screen, select S1 or S2 Measurement and press ENTER/MENU. Press INFO at any time to learn more about this procedure. A yellow screen will appear with detailed instructions and information.

The following calibration routine is covered:

1. Slope Calibration Slope cal with pure water and a standard of known turbidity
2. Standardize Calibration Standardizing the sensor to a known turbidity
3. Grab Calibration Standardizing the sensor to a known turbidity based on a reference turbidimeter

The screenshot shows the calibration interface with the following elements:

- Header: **S1: 7.00pH 25.2°C** **S2: 0.056 μ S/cm 52.1°C**
- Section: **Calibrate what?**
- Buttons:

S1 Measurement	Output 1
S1 Temperature	Output 2
S2 Measurement	Output 3
S2 Temperature	Output 4
- Bottom right: **BACK**

1. To calibrate the turbidity loop using Slope Calibration with pure water and a standard of known turbidity, follow the step-by-step procedures displayed on-screen.
2. To calibrate the turbidity loop using Standardize Calibration by Standardizing the sensor to a known turbidity, follow the step-by-step procedures displayed on-screen.
3. To calibrate the turbidity loop using Grab Calibration by Standardizing the sensor to a known turbidity based on a reference turbidimeter, follow the step-by-step procedures displayed on-screen.

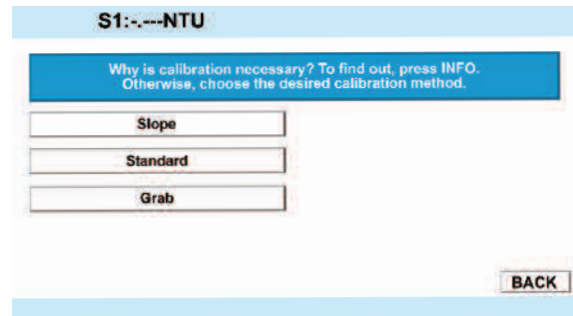

10.11 Pulse flow

A variety of pulse flow sensors can be wired to the Flow signal input board to measure flow volume, total volume and flow difference (if 2 Flow signal boards are installed). The 56 Flow signal board will support flow sensors that are self-driven (powered by the rotation of the impeller paddle-wheel).

To calibrate the pulse flow sensor, access the Calibration screen by pressing ENTER/MENU from the main screen, select S1 or S2 Measurement and press ENTER/MENU. Press INFO at any time to learn more about this procedure. A yellow screen will appear with detailed instructions and information.

The following calibration routine is covered:

1. K Factor A constant value representing pulses/Gal of flow
2. Frequency/Velocity & Pipe Alternate cal method – requires manual entry of frequency (Hz) per velocity and Pipe diameter used
3. In process Calibration based on known volume per unit of time
4. Totalizer Control User settings to stop, restart and reset total volume meter

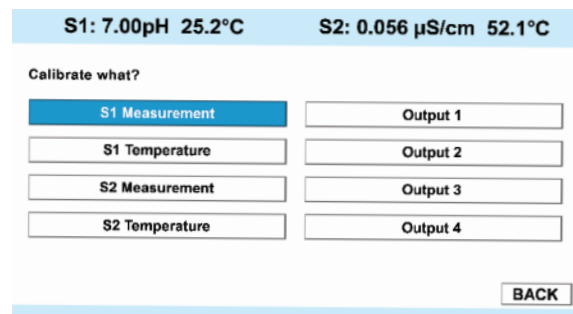

1. To enter a K Factor constant value representing pulses/Gal of flow, follow the step-by-step procedures displayed on-screen.
2. To calibrate pulse flow Frequency/Velocity & Pipe as an alternate cal method, follow the step-by-step procedures displayed on-screen.
3. To In-process Calibration the pulse flow sensor based on known volume per unit of time, follow the step-by-step procedures displayed on-screen.
4. To stop, restart and reset Totalizer Control total volume meter, follow the step-by-step procedures displayed on-screen.

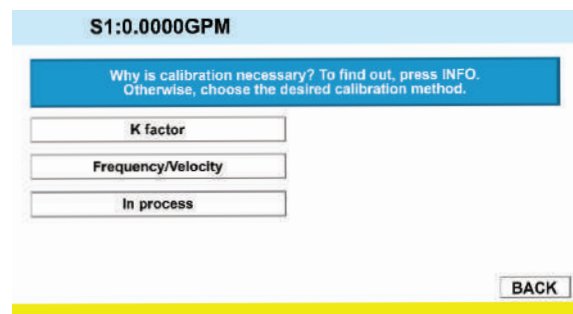

Section 11.0 HART® Communications

11.1 Introduction

The 56 can communicate with a HART host using HART Revision 5 or HART Revision 7. The revision of HART used by the 56 can be selected using the keypad/display or a HART master such as AMS or the 475 Handheld Communicator. The default version of HART is Revision 5. Since some HART hosts cannot accommodate HART 7, the choice of HART Revision should be based on the capabilities of the host, and should be chosen as a first step in configuration.

When HART 5 is chosen, the Device Revision of the 56 is Device Revision 1; when HART 7 is chosen the Device Revision is Revision 2, or higher, for later revisions of the 56. The Device Revision of the DD (Device Description) and install files for AMS and DeltaV used should be the same as the Device Revision of the 56.

HART 5 Device Identification (56 Revision 1):

Manufacturer Name: Rosemount

Model Name: 56

Manufacturer ID: 46 (0x2E)

Device Type Code: 86 (0x0056)

HART Protocol Revision: 5.1

Device Revision: 1

Capabilities: Supports all signal boards except the turbidity and flow/4-20mA input signal boards.

HART 7 Device Identification (56 Revision 2):

Manufacturer Name: Rosemount

Model Name: 56

Manufacturer ID: 46 (0x2E)

Device Type Code: 11862 (0x2E56)

HART Protocol Revision: 7.1

Device Revision: 2

Capabilities: Supports all signal boards.

HART 7 Device Identification (56 Revision 3):

Manufacturer Name: Rosemount

Model Name: 56

Manufacturer ID: 46 (0x2E)

Device Type Code: 11862 (0x2E56)

HART Protocol Revision: 7.1

Device Revision: 3

Capabilities: Supports all signal boards and the complete set of parameters for standardized PID with PID transport time feature and TPC control.

11.2 Physical Installation and Configuration

11.2.1 HART Wiring and Output Configuration

HART communications is superimposed on Analog Output 1 for all of the measurements and parameters of the 56. The 4-20 mA current of Analog Output 1 can be configured by the keypad display to be powered by the 56 (Output 1 power: Internal), or by an external 24 VDC power supply, or an I/O that provides power (Output 1 power: External).

11.2.2 HART Multidrop (Bus) Configuration

The HART Polling Address should be left at its default value of “0”, unless the 56 is used in a Multidrop configuration with up to 14 other transmitters. When the Polling Address is greater than “0”, the 4-20 mA output is held at 4 mA or below, and does not change in response to changes in the measurement in HART 5.

In HART 7, Loop Current Mode should be set to “On” to hold the current output to a minimum value. In both HART 5 and HART 7, Output Power should be set to “External” so that an external 24 VDC power supply can be used to power the multidrop bus.

11.2.3 HART Configuration

To access the HART Configuration screens, press the “HART” button in the Main Menu. The following controls are available:

HART Configuration Screen 1: Basic Definitions

S1: 7.00 pH 25.0°C		S2: 5.65 mS/cm 25.0°C	
Host HART mode	<input type="text" value="HART 7"/>		
Tag	<input type="text" value="????????"/>		
Long Tag	<input type="text" value="????????????????????"/>		
Polling Address	<input type="text" value="0"/>		
Loop current mode	<input type="text" value="On"/>		
Output 1 power	<input type="text" value="Internal"/>		
		<input type="button" value="NEXT"/>	<input type="button" value="BACK"/>
Fault/warning banner			

- Host HART mode – toggles between HART version 5 and HART version 7. If the HART host being used can accommodate HART 7, HART 7 should be chosen due to its larger feature set. If the host can only use HART 5, then HART 5 must be chosen.

NOTE: If the 56 is connected to a HART host and the HART version is changed, the host will likely detect the transmitter as a new transmitter with a different device revision number.

- Tag – The traditional 8 character HART tag number
- Long tag – HART tag number of up to 32 characters (HART 7 only).
- Polling address – Choose “0” unless Multidrop is being used. If Multidrop is being used, each transmitter should have its own polling address of from 1 to 15.
- Loop current mode – Set Output 1 current to a minimum value for multidrop applications (HART 7 only).

- Output 1 Power – Select “Internal” to power Output 1 with the 56. Select “External” to power the current loop with an external power supply, e.g. a host I/O that provides power (source) to the transmitter (sink).

HART Configuration Screen 2 Basic Definitions

- Burst command:
Off – Turns burst mode off

S1: 7.00 pH 25.0°C		S2: 5.65 mS/cm 25.0°C	
Host HART mode	<input type="text" value="HART 7"/>		
Tag	<input type="text" value="????????"/>		
Long Tag	<input type="text" value="????????????????????"/>		
Polling Address	<input type="text" value="0"/>		
Loop current mode	<input type="text" value="On"/>		
Output 1 power	<input type="text" value="Internal"/>		
		<input type="button" value="NEXT"/>	<input type="button" value="BACK"/>
Fault/warning banner			

Cmd 1 – Bursts the Primary Value

Cmd 2 – Bursts Loop Current + % of range of the Primary Value

Cmd 3 – Bursts Dynamic Variables (PV, SV, TV, & QV) + Loop Current

Cmd 9 – Bursts up to 8 Device Variables with time stamp and status (HART 7 only)

Cmd 33 – Bursts 4 Device Variables

Cmd 48 – Bursts Additional Transmitter Status Bits (HART 7 only)

Cmd 93 – Bursts Trend Data (HART 7 only)

- Find device cmd – Setting Find Device to “On”, enables the 56 to be identified by the host. The transmitter returns identity information including device type, revision level, and device ID.
- Response preambles – Preambles synchronize the receiver to the incoming data. Response preambles are the number of bytes of preambles (2 to 20) sent by the 56 at the start of a response packet.

11.3 Measurements Available via HART

A number of live measurements are made available by HART in addition to the main measurements such as pH or Conductivity. All of these measurements are called Device Variables, which can be mapped to the Dynamic Variables PV, SV, TV, and QV for regular reading by the typical HART host.

The 56 assigns the Dynamic Variables PV, SV, TV, and QV to Analog Outputs 1, 2, 3, and 4 respectively. Conversely, measurements assigned to Outputs 1 through 4, will automatically be assigned to PV through QV.

Each measurement board will have its own set of Device Variables, based on the secondary measurements used in making the main measurement. Appendix 1 shows the Device Variable for the each sensor boards used in the 56, and the Dynamic Variables, which they can be mapped to.

11.4 Diagnostics Available via HART

11.4.1 Status Information -- Device Status Bits

- Bit 0 Primary Variable out of Limits:**
This bit is set when PV is out of its limits.
- Bit 1 Non-primary Variable out of Limits:**
This bit is set when non PV is out of its limits.
- Bit 2 Loop Current Saturated:**
This bit is set when the Analog Output 1 current is less than 1.0 mA or greater than 22.0 mA and the Device Status Bytes bit 3 is not set.
- Bit 3 Loop Current Fixed:**
This bit is set when Analog Output 1 does not follow the process. This bit is cleared when Analog Output 1 follows the process.
- Bit 4 More Status Available:**
The "more status available" bit will be set when the device status condition occurs (i.e. bit goes from 0 to 1) on at least one of the Additional Transmitter Status bits are set.
- Bit 5 Cold Start:**
This bit is set when a Master Reset is performed either by Command 42, or a power cycle. This bit is cleared after the first response or burst. In the case of a burst, the first burst always goes to the primary master.
- Bit 6 Configuration Changed:**
This bit is set when the last bytes of an EEPROM writing sequence is completed. Since EEPROM writes are delayed until after the response, the immediate acknowledgement will not have the bit set, however, after the EEPROM write completes, the bit will be set. This bit applies to all EEPROM writes whether or not they apply directly to the configuration of the instrument or not. This bit is cleared when Command 38 is executed.
- Bit 7 Field Device Malfunction:**
This bit is set when any of the following conditions is true, and cleared when all of the following conditions are false:
- a) There is at least one main board fault.
 - b) There is at least one Sensor 1 fault.
 - c) There is at least one Sensor 2 fault.

11.4.2 Status Information – Extended Device Status Bits (HART 7 only)

- Bit 0 Maintenance Required:**
Any calibration error will set this bit. Any calibration for either Sensor 1 or Sensor 2 that fails will set this bit. This bit gets cleared if all device variables are calibrated successfully.

This bit is set to indicate that, while the device has not malfunctioned, the Field Device requires maintenance.
- Bit 1 Device Variable Alert:**
This bit will get set when at least one of device status byte of all the valid Device Variables does not equal to "good and not limited" (i.e. the higher 4 bits not equal to

0x1100).

This bit is set if any Device Variable is in an Alarm or Warning State. The host should identify the Device Variable(s) causing this to be set using the Device Variable Status indicators.

Bit 3 Critical Power Failures:

This bit will always be cleared on the 56.

11.4.3 Additional Transmitter Status (Command 48)

Additional Transmitter Status provides diagnostic status bits specific to the condition of sensors, sensor boards, and the main board of the 56. Calibration errors and notification of events, such as calibration in progress and relay activation are also indicated by status bits. Appendix 2 shows these bits organized according to the main board or applicable sensor board.

11.5 HART Hosts

A HART host can access live measurements, diagnostic messages, and provide a tool for configuring the measurement and calibrating the 56. Two examples are shown below:

11.5.1 AMS Intelligent Device Manager

The AMS Device Intelligent Device Manager is member of the AMS Suite of asset management applications, which provides tools for configuration, calibration, diagnosing, and documenting transmitters and valves. The following AMS windows are examples of these functions:

11.5.2 475 Field Communicator

HART (and Fieldbus) devices can be access in the field using the 475, which provides the same basic functionality as the AMS Intelligent Device Manager. Asset management information can be uploaded into the AMS database from the 475 for a common database for asset management data. The 475 uses a color menu driven display.

11.6 Wireless Communication using the 56

The 56 can communicate by Wireless HART using the Smart Wireless THUM Adaptor and

FIGURE 11-1 Main Measurement and Overall Status

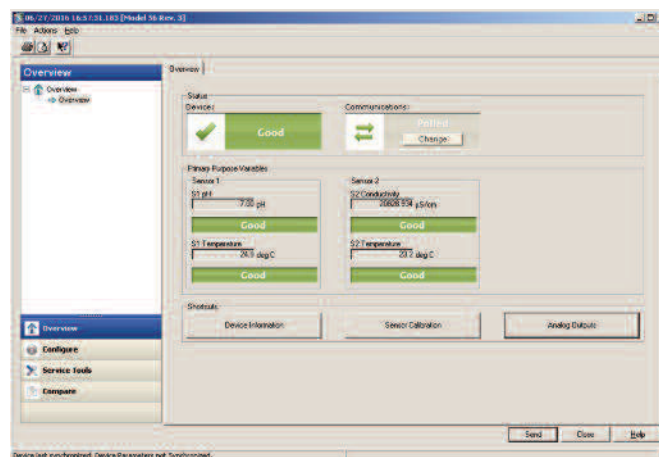

FIGURE 11-2 Device Variables and Dynamic Variables

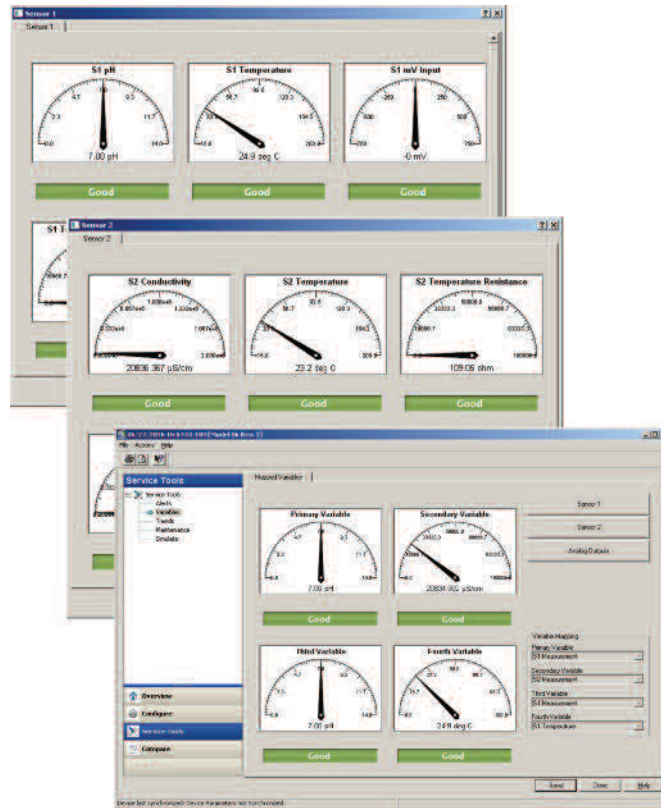

FIGURE 11-3 Diagnostic Messages (Additional Transmitter Status)

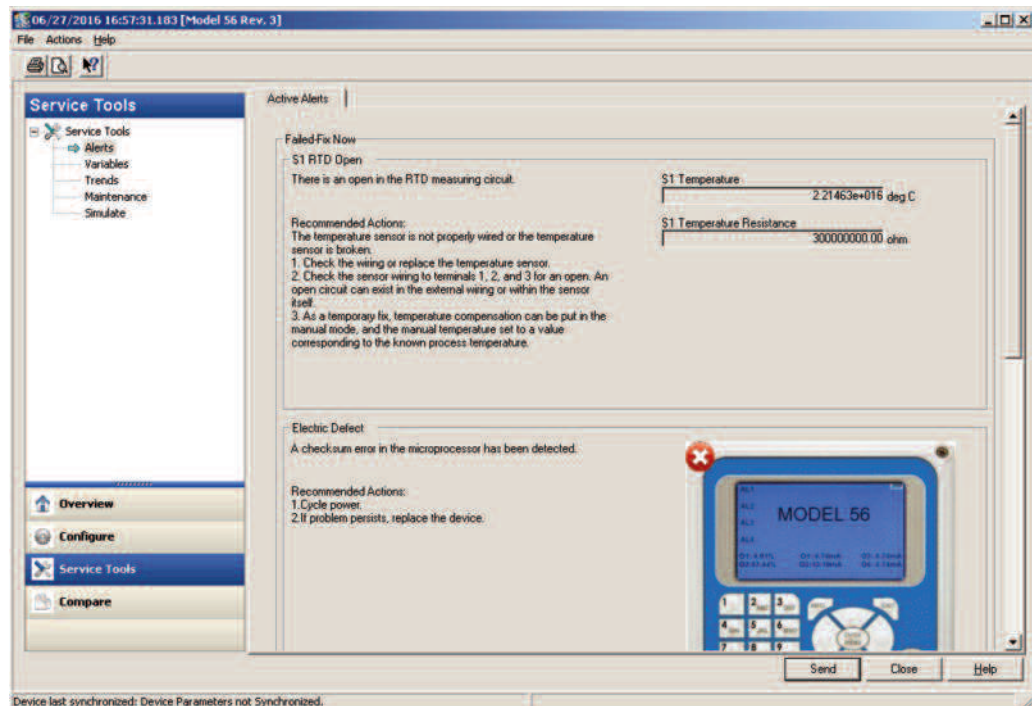

FIGURE 11-4 Configuration

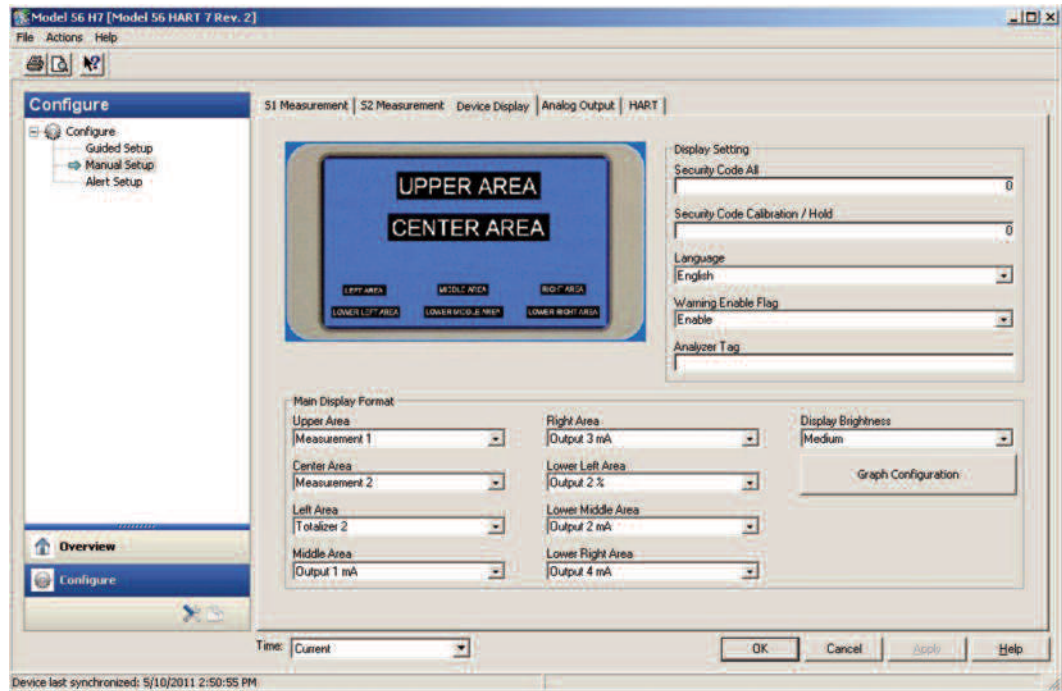
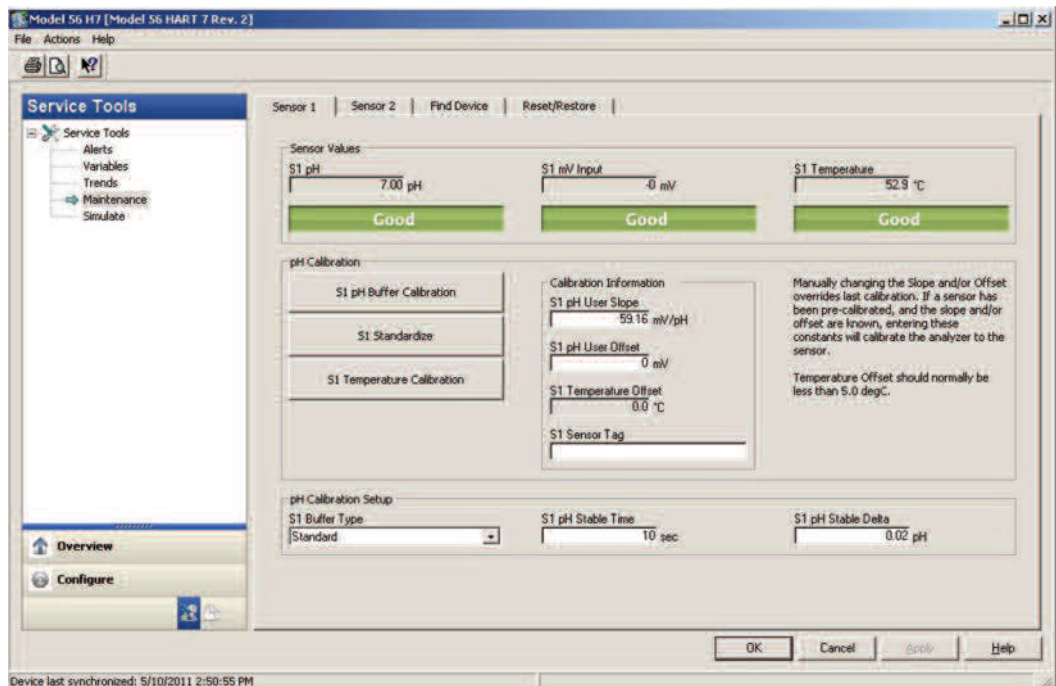

FIGURE 11-5 Calibration



the 1420 Smart Wireless Gateway. All the information available with the wired device can be accessed wirelessly, making it possible to have the measurements and benefits of HART communication in locations where running cable would be difficult or prohibitively expensive.

Although HART 5 or HART 7 can burst the Dynamic Variables (PV, SV, TV, & QV), HART 7 should be used with the THUM because up to 8 Device Variables can be continually burst using Command 9.

11.7 Field Device Specification (FDS)

For more details on the implementation of HART in the 56 and its command structure, the Field Device Specification for the relevant Device Revision should be consulted. They can be downloaded from our website.

Section 12.0 Profibus Communications

12.1 General

The 56 can communicate using Profibus DP-V1 by purchasing a 56 with a Profibus communication board installed (model code 56-PC-02-DP), or by adding a Profibus communications board to the standard 56 with HART communications.

The standard HART 56 analyzer can be converted to Profibus DP by adding a Profibus board. There are two different Profibus boards for the 56, which must be chosen to be compatible with the main board software version of the 56.

- If the 56 software version begins with a 2 (2.XX), Profibus board PN 24285-02 should be chosen.
- If the 56 software version begins with a 1 (1.XX), Profibus board PN 24285-01 should be chosen.

A 56 with Profibus communications retains all the analog and discrete functionality of the standard HART 56 transmitter. The four 4 to 20 mA analog outputs can be configured as analog outputs or PID control outputs.

The four discrete relay outputs can be configured for concentration control (high/low alarms with or without a delay timer), event based activation, timer based activation, or TPC (Duty Cycle/ Pulse Width Modulation) control.

12.2 Profibus Features

As outlined in the Device Description Data Field (GSD), the 56 has the following Profibus DP-V1 identification and capabilities:

Identification:

GSD Revision: 5
Vendor Name: Rosemount
Model Name: MODEL 56 PROFIBUS DP
Revision: V1.00
Identification Number: 0x10AA
Hardware Release: V1.00
Software Release: V1.00
Implementation Type: VPC3+C
Device: DP-V1 Slave

Baud Rates Supported:

All Profibus DP baud rates are supported, from 9.6 kbps to 12 Mbps.

Additional Capabilities:

- The 56 Profibus board supports the automatic transmission rate recognition. It automatically sets its baud rate to the transmission rate of the Profibus network, specified by the master.

- The DP device supports the function Set_Slave_Add for setting the slave address via the PROFIBUS. The slave address for the 56 can be set automatically or manually by the Profibus master.
The DP device supports DP-V0 cyclic services and Identification and Maintenance (I&M) function: - I&M 0
- The Minimum Slave Interval is 100 sec minimum interval between two poll cycles.

56 Modules

The 56 is a multiparameter device, which supports a number of combinations of 2 analytical measurements, and four relays which can be configured for a number of discrete functions. As a result, the 56 is defined as a modular station, to allow it to cover these measurements, relay status, and associated information. The 56 has 36 modules available and 33 can be inserted into the device. They include:

- The two main measurements, their units, and the measurement
- The temperature measurements from each board and their units
- Dual conductivity measurements: conductivity ration, percent passage and percent rejection
- Dual flow board measurements: flow recovery, flow difference, and flow unit
- Alarm relays (4 possible): their type, state, logic assignment and simulate status

Details of the module are in Section 12.3 Profibus Communications.

56 Device Diagnostics

A number of diagnostic bits are provided via Profibus, which cover the fault and warning messages for the 56 main board, signal boards, and measurements. They are organized as follows:

Table 12-1. Device Diagnostic Bits

Diagnostic Bits*	Bit Description
16	Change in Diagnostic Data
24-27	Main Board Faults
33-38	Main Board Warnings
40-57	Signal Board 1 and Measurement Faults
72-89	Signal Board 2 and Measurement Faults
104-121	Signal Board 1 and Measurement Warnings
136-153	Signal Board 2 and Measurement Warnings

*Bit position after the header byte.

Details of the diagnostic bits appear in Tables 12.3.10 and 12.3.11.

12.3 Profibus Communications

12.3.1 Configuring the 56 for Profibus Communications

Baud Rates

The 56 supports all the baud rates of Profibus DP as shown in Table 12.2.1 below. Since the 56 supports transmission rate recognition, it will recognize the baud rate used on the network, and set its own baud rate to match the network's rate.

Table 12-2. Baud Rates Supported

Baud Rate	Maximum Response Time for Responders (unit is bit time)
9.6 kbps	60
19.2 kbps	60
45.45 kbps	60
93.75 kbps	60
187.5 kbps	60
500 kbps	100
1.5 Mbps	150
3 Mbps	250
6 Mbps	450
12 Mbps	800

Slave Address

The 56 supports the set slave address function, which makes it possible for the Profibus master to set the slave address of the 56. Some Profibus masters cannot set slave addresses, and the slave addresses have to be set in each slave device. If this is case, the slave address can be set in the 56 by pressing the Enter/Menu key and selecting DP: Profibus, which will launch the Profibus configuration window:

Live display

Address

Profi cable diagnostics ▼

Fault/warning banner

- The Profibus address is writeable up to a value of 126.
- At the same time the slave address is being set, Profibus cable diagnostics should be enabled. These diagnostics provide a useful tool for troubleshooting cable connection problems.

12.3.2 Profibus Faults and Warnings

Faults

The 56 displays the following hardware faults associated with problems related to the Profibus board and its connection to the main board:

- **Profibus board mismatch** - The revision of the installed Profibus board is not compatible with the main board of the transmitter. Note the revisions of the Profibus board and the main board of the transmitter and contact the factory.
- **Self-test failed** - At power up, the Profibus board conducts several internal self tests. At least one of them failed.
 1. Try to reset the analyzer by cycling the power.
 2. Replace the Profibus board
- **Internal communication failed** - The main board detects the Profibus board, but the Profibus board is not communicating with the main board.
 1. Try to reset the analyzer by cycling the power.
 2. Check the interconnecting cable between the Profibus and main board.
 3. Replace the Profibus board.

Warnings

Warnings related to cable problems and software compatibility are also displayed, if Profibus cable diagnostics are enabled:

- **Cable shorted or open** - No Profibus cable is connected, or the A and B leads of the cable are shorted.
- **Check Profibus Cable** - The A and B leads in the Profibus cable may be reversed. If standard Profibus cable is used, the green lead should be wired to position A and the red lead to position B. The bus may not have a terminator, or it may not be turned on. Check to see that a terminator is present and turned on.
- **Profibus function limited** - The Profibus board has new features that the main board software does not support. If this is the case, the minor revision number of the Profibus board will be greater than the minor revision number of the main board. Replace the main board.

Details on these faults and warnings are accessed like any other fault or warning in the 56: Press the INFO key and then select “Faults – fix now” or “Warnings – fix soon.”

LED Diagnostics

The Profibus board itself displays diagnostic information via an LED, which is located on the upper right side of an installed board:

- **Slow blink** – No cable is present or the connection is shorted
- **Slow, even blinking** – reversed A and B cable connection
- **Quick flashing** – Profibus message detected
- **1 second blinking** – self-test failure
- **Off** – no power or a defective or missing ribbon cable

Diagnostic Information

The 56 provides diagnostic information on Profibus communications, which is accessed by pressing the INFO key and then selecting “Profibus information” to launch the window below:

Live display	
Address	<input type="text" value="3"/>
Baud rate	<input type="text" value="9600"/>
Master detected	<input type="text" value="yes"/>
POST	<input type="text" value="0"/>
Lpf output	<input type="text" value="60"/>
Rx char count	<input type="text" value="8"/>
<input type="button" value="NEXT"/> <input type="button" value="BACK"/>	
Fault/warning banner	

- Address – displays the address being used by the 56 on the network
- Baud rate – the baud rate of the 56 and the network
- Master detected – If the master is not detected, the host and analyzer are not communicating. Check wiring connections, make sure the addresses match, and try changing the baud rate.
- POST, Lpf output, Rx character count – POST is the power-on self test. POST and the remaining parameters on this window are used as factory diagnostics only.

Pressing the NEXT button brings up the final diagnostic parameter, the software version used by the Profibus board:

Live display	
Profibus bd SW ver	<input type="text" value="1.26"/>
<input type="button" value="BACK"/>	
Fault/warning banner	

12.4 Data Transmission

General

The 56 uses RS-485 communication technology for transmission. When messages are transmitted on Profibus networks, for word transfer (more than one byte), the high byte is transferred first, followed by the low byte (Big-Endian/Motorola format).

56 Modules

The details of measurement modules and relay modules are shown below in the following tables:

12.4.1 Measurement Modules

Table 12-3. Measurement Modules

Module	Module Name	Data Type	Size Bytes	Identifiers
	Signal Input Board 1			
1	PV1 Value	float	4	0x41,0x83,0x01
2	PV1 Unit	uint	2	0x41,0x81,0x02
3	PV1 Type	uchar	1	0x41,0x80,0x03
4	Temperature1	float	4	0x41,0x83,0x04
5	Temperature1 Unit	uint	2	0x41,0x81,0x05
	Signal Input Board 2			
6	PV2 Value	float	4	0x41,0x83,0x06
7	PV2 Unit	uint	2	0x41,0x81,0x07
8	PV2 Type	uchar	1	0x41,0x80,0x08
9	Temperature 2	float	4	0x41,0x83,0x09
10	Temperature 2 Unit	uint	2	0x41,0x81,0x0A
	Dual Conductivity Input Boards			
11	Conductivity Ratio	float	4	0x41,0x83,0x0B
12	% Passage	float	4	0x41,0x83,0x0C
13	% Rejection	float	4	0x41,0x83,0x0D
	Dual Flow Input Boards			
14	Flow Recovery	float	4	0x41,0x83,0x0E
15	Flow Difference	float	4	0x41,0x83,0x0F
16	Flow Unit	uint	2	0x41,0x81,0x10

Table 12-4. Measurement Unit Codes and Units

Unit Code	Unit	Unit Code	Unit	Unit Code	Unit
1001	°C	1212	µA	1364	GPH
1002	°F	1213	nA	1423	ppm
1034	m3	1243	mV	1424	ppb
1038	L	1274	pH	1425	ppth
1043	ft3	1281	Ohm	1521	ppb-ppm
1048	Gallon	1282	Gohm	1522	ug/L-mg/L
1059	h	1283	Mohm	1523	None
1060	d	1284	Kohm	1524	% Oxygen in Gas
1061	m/sec	1289	mS	1525	ppm Oxygen in Gas
1067	ft/sec	1290	µS	1526	NTU
1105	g/L	1295	Ohm-cm	1527	FTU
1133	kPa	1302	mS/cm	1528	FNU
1137	bar	1342	%	1551	S/cm
1138	mbar	1349	m3/hour	1552	µS/cm
1140	atm	1352	L/min	1555	M Ohm-cm
1155	in Hg	1353	L/hour	1556	k Ohm-cm
1157	mm Hg	1357	cu ft/min	1558	mg/L
1190	kwatt	1358	cu ft/hour	1559	µg/L
1211	mA	1363	GPM	1560	% Saturation

Table 12-5. Measurement (PV 1 and PV 2) Types

Types	Measurement	Types	Measurement
0	Unknown	14	Custom Concentration
1	pH	15	Total Dissolve Solids
2	ORP	16	Salinity
3	Redox	17	Oxygen
4	Ammonia	18	Ozone
5	Fluoride	19	Free Chlorine
6	Custom ISE	20	pH Independent Free Chlorine
7	Conductivity	21	Total Chlorine
8	Resistivity	22	Chloramine
9	NaOH	23	Flow
10	HCl	24	mA Input
11	Low Range H ₂ SO ₄	25	Turbidity
12	High Range H ₂ SO ₄	26	Total Suspended Solids
13	NaCl		

Measurement modules provide the PV value for each signal board, the PV unit (Table 12-3), and the PV type (Table 12-4)

12.4.2 Relay Modules

Table 12-6. Measurement Modules

Module	Module Name	Data Type	Size Bytes	Identifiers
	Relay 1			
17	Alarm1 Type	uchar	1	0x41,0x80,0x11
18	Alarm1 State	uchar	1	0x41,0x80,0x12
19	Alarm1 Logic	uchar	1	0x41,0x80,0x13
20	Alarm1 Assignment	uchar	1	0x41,0x80,0x14
21	Alarm1 Simulate Status	uchar	1	0x41,0x80,0x15
	Relay 2			
22	Alarm2 Type	uchar	1	0x41,0x80,0x16
23	Alarm2 State	uchar	1	0x41,0x80,0x17
24	Alarm2 Logic	uchar	1	0x41,0x80,0x18
25	Alarm2 Assignment	uchar	1	0x41,0x80,0x19
26	Alarm2 Simulate Status	uchar	1	0x41,0x80,0x1A
	Relay 3			
27	Alarm3 Type	uchar	1	0x41,0x80,0x1B
28	Alarm3 State	uchar	1	0x41,0x80,0x1C
29	Alarm3 Logic	uchar	1	0x41,0x80,0x1D
30	Alarm3 Assignment	uchar	1	0x41,0x80,0x1E
31	Alarm3 Simulate Status	uchar	1	0x41,0x80,0x1F
	Relay 4			
32	Alarm4 Type	uchar	1	0x41,0x80,0x20
33	Alarm4 State	uchar	1	0x41,0x80,0x21
34	Alarm4 Logic	uchar	1	0x41,0x80,0x22
35	Alarm4 Assignment	uchar	1	0x41,0x80,0x23
36	Alarm4 Simulate Status	uchar	1	0x41,0x80,0x24

Table 12-7. Alarm Types

Alarm Type Code	Alarm Type
0	Set Point Alarm
1	Interval Timer
2	TPC (Duty Cycle)
3	Bleed Alarm
4	Feed Alarm
5	Setpoint Alarm + Delay Timer
6	Date and Time Timer
7	Totalizer Timer
8	Fault Alarm
9	No Alarm Assigned to Relay

Table 12-8. Alarm States

0	Off
1	On

Table 12-9. Alarm Logic

Code	Logic
0	High Alarm
1	Low Alarm
2	USP Alarm (Contacting Conductivity Only)

Table 12-10. Alarm Simulation

Code	State
0	Off
1	De-Energize
2	Energize

Table 12-11. Alarm Assignment Codes

Sensor 1	Sensor 2	Variable Assigned
1	41	Process Variable
2	42	Temperature
4	44	Amperometric Sensor Current
7	47	Millivolt Input
9	49	Glass electrode Impedance
11	51	Reference Electrode Impedance
14	54	Raw Conductivity
15	55	Raw Resistivity
16	56	Turbidity
18	58	Flow Velocity
19	59	Totalized Flow
33	73	Free Ions
Dual Sensor and Main Board Assignments:		
	0	Main Board Temperature
	201	Conductivity Ratio
	202	% Rejection (Conductivity)
	203	% Passage (Conductivity)
	204	Calculated pH (Conductivity)
	205	Flow Ratio
	206	Percent Flow Ratio
	207	Flow Recovery
	208	Flow Difference
	209	Totalized Flow Difference

Relay Modules provide the alarm type, state, logic, assignment, and simulation status as shown in Tables 12-5 to 12-10:

12.4.3 Transmitter Diagnostic Bits

The 56 transmits diagnostic bits associated with main board and signal board faults and warnings, as well as faults and warning specific to the sensors used to make the various measurements. These bits are shown organized by main board, signal board and measurement, with and explanation of the fault or warning in Tables 12-11 to 12.13.

Table 12-12. Main Board Diagnostic Bits – Main Board Faults

Main Board Faults		
Bit	GSD Descriptor	Help
16	Change In Diagnostic Data	A diagnostic bit has changed state
24	Main Board CPU Error	The main board software is corrupted. 1. Try to reset the analyzer by turning the power off then on again. 2. Call the factory. The main board must be replaced (at the factory).
25	Main Board User Data Error	The main board user EEPROM data is corrupted. 1. Try to reset the analyzer by turning the power off then on again. 2. Reset the analyzer to factory default settings. Go to main menu and select Reset. Re-enter user settings and repeat calibra-
26	Main Board Factory Data Error	The main board factory EEPROM data is corrupted. 1. Try to reset the analyzer by turning the power off then on again. 2. Call the factory. The main board must be replaced (at the factory).
27	Main Board Wrong Power Supply	The existing power supply is incorrect for the turbidity sensor. Replace power supply.

Table 12-13. Main Board Diagnostic Bits – Main Board Warnings

Main Board Warnings		
Bit	GSD Descriptor	Help
33	Unknown Power Supply	The main board software cannot identify the power supply. 1. Check the ribbon cable connections between the power supply board and main board. 2. Check the ribbon cable for damage. 3. Consult the factory.
34	Line Frequency Unknown	The analyzer has detected an AC power source, but the frequency is not 50 Hz or 60 Hz. 1. Check the ribbon cable connections between the power supply board and main board. 2. Check the mains frequency.
35	Main Board Factory Cal	The analyzer was not calibrated at the factory. 1. Try to reset the analyzer by turning the power off then on again. 2. Call the factory.
36	Keypad Error	The analyzer has detected shorted contacts in at least one key. Call the factory.
37	Overheating LCD Warning	High ambient temperature and high temperature inside the analyzer is causing the LCD to overheat, reducing the operating life of the display. The analyzer automatically begins reducing the brightness of the display at 55 °C (131 °F). At 78 °C (172 °F) analyzer turns off the display and stops storing data in the flash drive (if one is installed). At 85 °C (185 °F) the analyzer turns off the analog current outputs. At 90 °C (194 °F) the analyzer turns off the relays. As the temperature cools, the functions are restored. To prevent shutdown of the display and loss of other analyzer functions, move the analyzer to a cooler place.
38	Excess Output Current	One or more analog outputs are drawing too much current, and all outputs have been shut down. The analyzer will check the current every 30 seconds and will return the outputs to normal operation once the current drops below the shutdown limit. Check analog output wiring. A short from the positive terminal to ground will cause excessive current to flow. Even if only one output is shorted, all four outputs will be shut down. If no wiring problems are found, the main board has been damaged and must be replaced.

Table 12-14. Signal Board Diagnostic Bits

Diagnostic Bits		
Signal Board 1 / 2	GSD Descriptor	Help
40 / 72	SN 1/2 Board Unknown (Fault)	The analyzer automatically recognizes the sensor board on power up. Sensor board unknown implies the sensor board is new and not supported or there is a bad connection between the sensor board and the main board. 1. Check ribbon cable connections at the main board and sensor board. 2. Inspect ribbon cable for damage and replace if necessary. 3. Replace sensor board.
41 / 73	SN 1/2 HW SW Mismatch error (Fault)	The main board software does not match the sensor board software. 1. Check ribbon cable connections at the main board and sensor board. 2. Inspect ribbon cable for damage and replace if necessary. 3. Replace sensor board.
42 / 74	SN 1/2 Incompatible Error (Fault)	The sensor board software is not supported by the main board. Either the sensor board software is too old or the main board software is too old. Replace the main board with one compatible with the sensor board. Call the factory for assistance. The main board must be replaced at the factory.
43 / 75	SN 1/2 Not Detected	The sensor board is no longer being detected. 1. Check ribbon cable connections at the main board and sensor board. 2. Inspect the ribbon cable for damage and replace if necessary. 3. Replace the sensor board.
44 / 76	SN 1/2 Not Communicating (Fault)	The analyzer automatically recognizes the sensor board on power up. Sensor not communicating implies there is a bad connection between the sensor board and the main board or there is a bad component on the sensor board. 1. Check ribbon cable connections at the main board and sensor board. 2. Inspect the ribbon cable for damage and replace if necessary. 3. Replace the sensor board.
45 / 77	SN 1/2 CPU error (Fault)	The sensor board software is corrupted. 1. Try to reset the analyzer by turning the power off then on again. 2. If cycling the power does not help, replace the sensor board.
46 / 78	SN 1/2 Factory Data Error (Fault)	The factory-entered EEPROM data on the sensor board is corrupted. 1. Try to reset the analyzer by turning the power off then on again. 2. Replace the sensor board.
47 / 79	SN 1/2 ADC Error (Fault)	There is a bad hardware component on the sensor board. Replace the sensor board.
50 / 82	SN 1/2 Hardware Error (Fault)	Hardware error means there is a missing or bad hardware component on the sensor board. Replace the sensor board.
54 / 86	SN 1/2 User Data Error (Fault)	The user-entered EEPROM data on the sensor board is corrupted. 1. Try to reset the analyzer by turning the power off then on again. 2. Replace the sensor board.
55 / 87	SN 1/2 EEPROM Write Error (Fault)	There is a bad CPU on the sensor board. 1. Try to reset the analyzer by turning the power off then on again. 2. Replace the sensor board.
104 / 136	SN 1/2 Need Factory Cal (Warning)	The sensor board was not calibrated at the factory. Call the factory.

Table 12-14. Signal Board Diagnostic Bits – continued

Temperature Faults and Warnings		
Signal Board 1 / 2	GSD Descriptor	Help
48 / 80	SN 1/2 RTD Open (Fault)	The temperature measuring circuit is open. The RTD is improperly wired or the RTD IN or RTD RTN are broken. 1. Check RTD wiring connections. 2. Check RTD for open or short circuits.
49 / 81	SN 1/2 RTD Out Of Range (Fault)	The resistance of the temperature sensing element (RTD) is too large or too small. The sensor is wired improperly, or the temperature sensor is not recognized by the sensor board. 1. Check sensor wiring. 2. Check that the temperature sensing element is compatible with the analyzer. It must
105 / 137	SN 1/2 Temperature High (Warning)	pH and Amperometric Measurements The measured temperature is greater than 155 °C. 1. Check wiring. 2. Disconnect the sensor and check the resistance between the RTD in and RTD return wires. It should be about 110 ohm at room temperature. 3. Replace the sensor if the RTD has failed.
		Contacting Conductivity Measurements The measured temperature is greater than 300 °C. 1. Check wiring. 2. Disconnect sensor and check resistance between RTD in and RTD return wires. It should be about 1100 ohm at room temperature. 3. Replace sensor if RTD has failed.
		Toroidal Conductivity Measurements The measured temperature is greater than 200 °C. 1. Check wiring. 2. Disconnect sensor and check resistance between RTD in and RTD return wires. It should be about 110 ohm at room temperature. 3. Replace sensor if RTD has failed.
106 / 138	SN 1/2 Temperature Low (Warning)	pH and Amperometric Measurements The measured temperature is less than -20 °C. 1. Check wiring. 2. Disconnect the sensor and check the resistance between the RTD in and RTD return wires. It should be about 110 ohm at room temperature. 3. Replace the sensor if the RTD has failed.
		Contacting and Toroidal Conductivity Measurements The measured temperature is less than -40 °C. 1. Check wiring. 2. Disconnect the sensor and check the resistance between the RTD in and RTD return wires. It should be about 110 ohm at room temperature. 3. Replace the sensor if the RTD has failed.
107 / 139	SN 1/2 RTD Sense Line Open (Warning)	The analyzer uses the sense line to correct for the resistance of the RTD leads and for changes in the lead wire resistance caused by variations in ambient temperature. 1. Check wiring. 2. Disconnect the sensor and check for continuity between the RTD return and RTD sense leads at the sensor. 3. If sensor has failed, use a wire jumper to connect the RTD sense and return terminals. 4. Replace the sensor.

Table 12-14. Signal Board Diagnostic Bits – continued

pH / ISE Faults and Warnings		
Signal Board 1 / 2	GSD Descriptor	Help
51 / 83	SN 1/2 Ref Z Too High (Fault)	The impedance of the reference junction is too high. 1. Confirm that the sensor is fully immersed in the process liquid. 2. High reference impedance implies the reference junction is fouled or depleted. Replace the sensor. 3. Some sensors are designed to have high reference impedance. If this is the case, change the reference impedance setting (in the measurement menu) to high.
52 / 84	SN 1/2 Glass Z Too High (Fault)	The sensing element in a pH sensor is a thin glass membrane. Normally, the impedance of the membrane is 80 – 100 megohm. As the glass ages, impedance increases. A large increase in impedance implies the sensor is near the end of its useful life. Certain ion selective electrodes (fluoride, ammonia, and ammonium) also have high impedance sensing elements. 1. Confirm that the sensor is fully immersed in the process liquid. 2. If sensor performance in buffers and the process is acceptable, increase the impedance limit. 3. Replace the sensor.
53 / 85	SN 1/2 Broken Glass Fault (Fault)	The sensing element in a pH sensor is a thin glass membrane. In a good sensor, the glass impedance is very high. If the glass bulb breaks or cracks, the impedance drops to a very low value, and the broken glass fault appears. Certain ion selective electrodes (fluoride, ammonia, and ammonium) also have high impedance sensing elements. 1. Inspect the sensor for obvious damage. 2. Check the sensor in buffers. If the sensor does not respond to pH changes, the glass is broken. 3. Replace the sensor.
108 / 140	SN 1/2 Out Of Range pH Brd (Warning)	The pH input is outside the range -750 mV to +750 mV or the ORP or ISE input is outside the range -1500 mV to +1500 mV. Check sensor wiring. Replace sensor.
111 / 143	SN 1/2 No Solution Gnd (Warning)	The sensor is not properly wired. Check wiring.
115 / 147	SN 1/2 Broken Glass Disabled (Warning)	The impedance of the sensing glass in a pH sensor is a strong function of temperature. For the impedance to be a useful indicator that the sensing glass is cracked or broken, it must be corrected for temperature. If the process temperature exceeds the correction cut-off temperature, the broken glass fault is automatically disabled. The analyzer recalculates the cut-off temperature every time the sensor is calibrated. The cutoff temperature is about 115 °C.

Table 12-14. Signal Board Diagnostic Bits – continued

Conductivity Faults and Warnings		
Signal Board 1 / 2	GSD Descriptor	Help
109 / 141	SN 1/2 Out Of Range Cont/Tor Brd	<p>Contacting Conductivity Measurements The raw conductance is greater than 1 S.</p> <ol style="list-style-type: none"> 1. Check sensor wiring. 2. Check sensor cleanliness. 3. Check the sensor electrodes for shorts.
		<p>Toroidal Conductivity Measurements The raw conductance is greater than 2 S.</p> <ol style="list-style-type: none"> 1. Check sensor wiring. 2. Check sensor electrodes for shorts.
112 / 144	SN 1/2 -ve Rdng Cont/Tor Brd (Warning) (Negative conductivity reading)	<p>Contacting Conductivity Measurements Negative Reading: During zero calibration, the analyzer makes a correction for the conductance equivalent of the cable capacitance. If the difference between the measured conductance and the zero correction is less than -2 uS, the negative reading warning appears.</p> <ol style="list-style-type: none"> 1. Repeat zero calibration. Be sure the sensor is completely dry. 2. Confirm that the sensor is completely submerged in the process liquid.
		<p>Toroidal Conductivity Measurements Negative Reading: During zero calibration, the analyzer makes a correction for small offsets in the signal that exist even when the conductance is zero. If the difference between the measured conductance and the zero correction is less than -50 uS, the negative reading warning appears.</p> <ol style="list-style-type: none"> 1. Repeat zero calibration. Be sure the sensor is completely dry. 2. Confirm that the sensor is completely submerged in the process liquid.
113 / 145	SN 1/2 Out Of Range (Warning)	<p>The calculated concentration or temperature is out of range.</p> <ol style="list-style-type: none"> 1. NaOH: 0 – 12.00%, 0 - 100 °C. 2. HCl: 0 – 15.00%, 0 - 65 °C. 3. H₂SO₄ (low): 0 – 25.00%, -1 - 99 °C. 4. H₂SO₄ (high): 96.0 – 99.7%, 4 - 110 °C. 5. NaCl: 0 – 20.00%, 0 - 100C. 6. Salinity: 2 – 42 part per thousand, -2 - 35 °C.

Amperometric Faults and Warnings		
Signal Board 1 / 2	GSD Descriptor	Help
110 / 142	SN 1/2 -ve Rdng Amp/Oxy Brd (Warning) (Negative amperometric reading)	<p>The analyzer subtracts the zero current (the current generated by the sensor when no analyte is present) from the measured current before converting the result into a concentration value. A negative reading implies the zero step was done before the sensor reached a stable zero current. Repeat the zero calibration. It may require several hours or as long as overnight for the zero current to stabilize.</p>
114 / 145	SN 1/2 Pressure Sensor Broken (Warning)	<p>The pressure sensor on the oxygen sensor board has failed, or it is not installed, or it is installed backwards. Replace the sensor board.</p>

Table 12-14. Signal Board Diagnostic Bits – continued

Flow / 4 to 20 mA Input Faults and Warnings		
Signal Board 1 / 2	GSD Descriptor	Help
117 / 149	SN 1/2 No Flow Detected (Warning)	The analyzer has sensed no flow for at least ten seconds. 1. Check that the flow exceeds the minimum flow recommended for the sensor. 2. Check wiring. 3. Check the sensor
118 / 150	SN 1/2 -ve Current (Warning) (Negative 4-20 mA input current)	The input current from the device is less than -0.1 mA. 1. The polarity is wrong. Reverse wiring. 2. Check the current source.
119 / 151	SN 1/2 Excessive Current (Warning)	The input current from the device is greater than 22.00 mA. 1. Check wiring. 2. Check the current source.
120 / 152	SN 1/2 Low Current (Warning)	The input current range has been set to 4-20 mA, and the input current is less than 3.6 mA. 1. Check the input current range configuration. 2. Check configuration of current source.

Turbidity Faults and Warnings		
Signal Board 1 / 2	GSD Descriptor	Help
27	Main Board Wrong Power Supply (Fault)	The existing power supply is incorrect a the turbidity sensor. Replace power supply.
56 / 88	SN 1/2 Lamp Led Fail (Fault)	The lamp or LED has failed. 1. Try to reset the analyzer by turning the power off then on again. 2. Replace the sensor.
57 / 89	SN 1/2 Disconnected (Fault)	The turbidity sensor cable is disconnected at either the sensor or the sensor board. 1. Confirm that the cable is tightly connected to the sensor receptacle. If necessary, completely disconnect the cable and reconnect it. Check connectors for cleanliness. 2. Confirm that the cable is tightly connected to the board receptacle. If necessary,
116 / 148	SN 1/2 Weak Lamp (Warning)	The lamp intensity has decreased below the lower limit. The lamp is aging and should be replaced as soon as possible.
121 / 153	SN 1/2 Needs calibration (Warning)	The analyzer continuously measures the intensity of the lamp and uses the measured intensity to correct for the effect of lamp drift on measured turbidity. As the lamp ages and its intensity drops, the target intensity is adjusted. Readjusting the target intensity introduces a significant error. To remove the error, the sensor must be recalibrated. 1. Recalibrate the sensor in 20 NTU standard. 2. Order replacement sensor.

12.5 Installation and Wiring

12.5.1 General

This section shows the recommended method of wiring the Profibus cable to the Profibus card of the 56.

Recommended Wiring Steps

1. Feed the Profibus cable through a cable gland fitting. Install the cable gland fitting into the enclosure opening on the leftmost side of the enclosure nearest the front of the door hinge. See photo. Note that the power cable should be installed in the leftmost side of the enclosure farthest from the front of the door hinge, as shown in the photo below:

FIGURE 12-1. Proper enclosure opening locations for cable installation.



2. Secure the Profibus cable with a cable gland fittings and nut from the outside of the enclosure to ensure a proper seal. Note that the cable gland fittings (PN 23554-00 - Cable Gland Kit, Quantity 5) do not require the securing nut inside the enclosure to properly install the fitting. Simply thread the fitting into the grounding plate inside the enclosure and tighten.

Once the gland fitting is tightly screwed into the enclosure and internal grounding plate, only the external nut needs to be tightened to properly seal the Profibus cable.

FIGURE 12-2, Cable gland fittings secured on internal grounding plate.

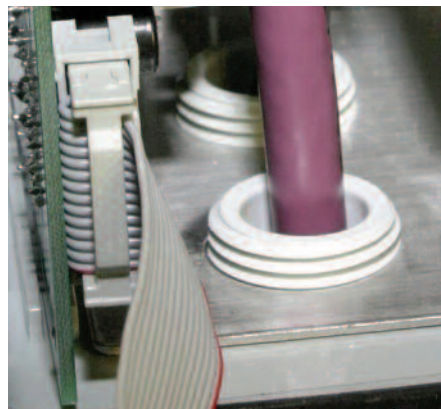

- Remove the 4-lead terminal block which is installed on the Profibus slide-in board. This photo shows the 4-lead terminal block installed onto the board:

FIGURE 12-3. Profibus board showing removable 4-lead terminal block

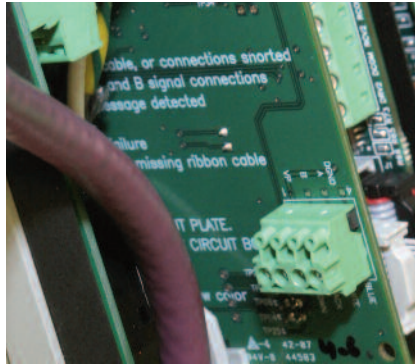
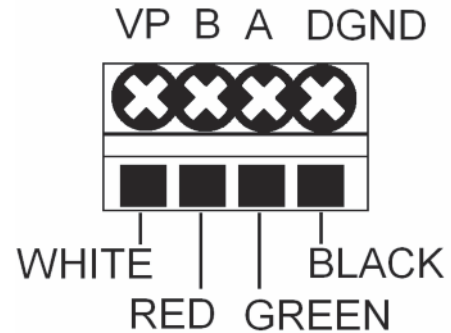

FIGURE 12-4. 4-Lead Terminal Block



- Wired the two leads of the Profibus cable (red and green) to the A and B positions of the 4-lead removable terminal block. A #0 Philips head screw driver is required to open and close the terminal posts on the terminal block. The lead positions are labeled on the Profibus card (A and B) to assist in wiring.

Note: For successful communication using standard Profibus cable:
 The Green color lead must be wired to lead position A (Rx/D/TxD-N).
 The Red color lead must be wired to lead position B (Rx/D/TxD-P).
 The VP and DGND (digital ground) positions are used to a power bus terminator if required.

CAUTION

Make sure the Profibus cable is properly prepared. Unshielded wire leads can lead to poor signal integrity from the Profibus device to the Master

- After wiring the Profibus cable to the terminal block, slide the wired 4-lead terminal block onto the 4 pins protruding from Profibus board on the left side.

Photo shows the 4-lead terminal block properly wired to the Profibus board and installed onto the board.

Note: the Profibus cable must be directed downwards. The Profibus board can be partially or fully removed to allow easy insertion of the 4-lead terminal block onto the Profibus board.

- Ensure that the 10-lead ribbon cable is properly connected from the Profibus board to the left-most connector of the 3 10-pin shrouded connectors on the right side of the main circuit board.

Once power is wired to the unit (as shown in photo), the Profibus-configured 56 is ready for power up and communication on a Profibus network.

FIGURE 12-5. Complete Profibus board installation with ribbon cable attached.



Section 13.0 Maintenance

13.1 Overview

This section gives general procedures for routine maintenance of the 56 advanced analyzer. The analyzer needs almost no routine maintenance. Sensors require periodic inspection and cleaning. The calibration of the transmitter-sensor combination should be checked regularly, and the loop recalibrated if necessary.

CAUTION

Always depower the analyzer or disconnect the analyzer from the main power supply before opening the enclosure in a hazardous area.

WARNING



RISK OF ELECTRICAL SHOCK

Electrical installation must be in accordance with the National Electrical Code (ANSI/NFPA-70) and/or any other applicable national or local codes.



CAUTION: This symbol identifies a risk of electrical shock.



CAUTION: This symbol identifies a potential hazard. When this symbol appears, consult the manual for appropriate action.

13.2 Analyzer Maintenance

Periodically clean the analyzer window and housing as needed with a cloth dampened with water. Do not use abrasives or cleaning solutions.

13.3 USB Port

The USB communications port is protected by a NEMA-rated seal and cover. Do not remove the cover during cleaning. Never remove the USB port cover when the instrument is operated in a hazardous rated area.

Section 14.0 Return of Material

14.1 General

To expedite the repair and return of instruments, proper communication between the customer and the factory is important. Before returning a product for repair, call 1-949-757-8500 for a Return Materials Authorization (RMA) number.

14.2 Warranty Repair

The following is the procedure for returning instruments still under warranty:

1. Call Emerson for authorization.
2. To verify warranty, supply the factory sales order number or the original purchase order number. In the case of individual parts or sub-assemblies, the serial number on the unit must be supplied.
3. Carefully package the materials and enclose your “Letter of Transmittal” (see Warranty). If possible, pack the materials in the same manner as they were received.
4. Send the package prepaid to:
Emerson
8200 Market Blvd,
Chanhassen, MN 55317

RMA No. _____
Mark the package: Returned for Repair

Model No. _____

IMPORTANT

Please see second section of “Return of Materials Request” form. Compliance with the OSHA requirements is mandatory for the safety of all personnel. MSDS forms and a certification that the instruments have been disinfected or detoxified are required.

14.3 Non-Warranty Repair.

The following is the procedure for returning for repair instruments that are no longer under warranty:

1. Call Emerson for authorization.
2. Supply the purchase order number, and make sure to provide the name and telephone number of the individual to be contacted should additional information be needed.
3. Do Steps 3 and 4, above.

NOTE

Consult the factory for additional information regarding service or repair.

Appendix 1: HART and Device Variables

pH Device Variables		
Device Variable Name	Assignable to Dynamic Variables	Variable Range
Sensor 1 / 2 Measurement Type		
pH (1)	PV, SV, TV or QV	0 to 14 pH
ORP (2), Redox (3)	PV, SV, TV or QV	-1500 to 1500 mV
Ammonia (4), Fluoride (5), Custom ISE (6)	PV, SV, TV or QV	0 to 1000 ppm
		0 to 1000 ppb
		0 to 1000 mg/L
		0 to 1000 µg/L
		0 to 100 %
Measurement Parameters		
Sensor 1 / 2 Temperature	PV, SV, TV or QV	-15 to 200 °C
		5 to 360 °F
Sensor 1 / 2 Temperature resistance	TV or QV	0 to 100000 ohm
Sensor 1 / 2 mV input	PV, SV, TV or QV	-750 to 750 mV
Sensor 1 / 2 Glass impedance	PV, SV, TV or QV	0 to 2000 M
Sensor 1 / 2 Sensor impedance	PV, SV, TV or QV	0 to 2000 M
Sensor 1 / 2 Reference impedance	PV, SV, TV or QV	0 to 10000 k

Contacting and Toroidal Conductivity Device Variables		
Device Variable Name	Assignable to Dynamic Variables	Variable Range
Sensor 1 / 2 Measurement Type		
Conductivity (7)	PV, SV, TV or QV	0 to 2000000 μ S/cm
Resistivity (8)	PV, SV, TV or QV	0 to 50000000 ohm-cm
Concentration:		
NaOH (9)	PV, SV, TV or QV	0 to 12 %
HCl (10)	PV, SV, TV or QV	0 to 15 %
Low H2SO4 (11)	PV, SV, TV or QV	0 to 25 %
High H2SO4 (12)	PV, SV, TV or QV	96 to 99.7 %
NaCl (13)	PV, SV, TV or QV	0 to 25 %
Custom Concentration (14)	PV, SV, TV or QV	0 to 1000 ppm
		0 to 1000 mg/L
		0 to 100 g/L
		0 to 100 %
		0 to 1000 None
TDS (15)	PV, SV, TV or QV	0 to 10000 ppm
Measurement Parameters		
Sensor 1 / 2 Temperature	PV, SV, TV or QV	-15 to 200 °C
		5 to 360 °F
Sensor 1 / 2 Temperature resistance	TV or QV	0 to 100000 ohm
Sensor 1 / 2 Conductance	TV or QV	0 to 2000000 μ S
Sensor 1 / 2 Input resistance	TV or QV	0 to 500 k
Sensor 1 / 2 Raw Conductivity	PV, SV, TV or QV	0 to 2000000 μ S/cm
Sensor 1 / 2 Raw Resistivity	PV, SV, TV or QV	0 to 50000000 ohm-cm
Dual Conductivity Measurements:		
Conductivity Ratio	PV, SV, TV or QV	0 to 10000
% Rejection	PV, SV, TV or QV	0 to 100 %
% Passage	PV, SV, TV or QV	0 to 100 %
Calculated pH (Contacting only)	PV, SV, TV or QV	0 to 14 pH

Turbidity Device Variables		
Device Variable Name	Assignable to Dynamic Variables	Variable Range
Sensor 1 / 2 Measurement Type		
Turbidity (25)	PV, SV, TV or QV	0 to 200 FNU
		0 to 200 FTU
		0 to 200 NTU
TSS (26)	PV, SV, TV or QV	0 to 1000 ppm
		0 to 1000 mg/L
		0 to 1000 None
Measurement Parameters		
Sensor 1 / 2 Lamp Voltage	TV or QV	0 to 2000 mV

Amperometric Device Variables		
Device Variable Name	Assignable to Dynamic Variables	Variable Range
Sensor 1 / 2 Measurement Type		
Salinity (16)	PV, SV, TV or QV	0 to 36 ppt
Oxygen (17)	PV, SV, TV or QV	0 to 100 ppm
		0 to 1000 ppb
		0 to 100 mg/L
		0 to 1000 µg/L
		0 to 300 % Saturation
		0 to 760 mmHg
		0 to 30 inHg
		0 to 1 bar
		0 to 1000 mbar
		0 to 100 kPa
		0 to 1 atm
Ozone (18), Free Chlorine (19), pH Independent Free Chlorine (20), Total Chlorine (21), Chloramine (22)	PV, SV, TV or QV	0 to 20 ppm
		0 to 1000 ppb
		0 to 20 mg/L
		0 to 1000 µg/L
Measurement Parameters		
Sensor 1 / 2 Temperature	PV, SV, TV or QV	-15 to 200 °C
		5 to 360 °F
Sensor 1 / 2 Temperature resistance	TV or QV	0 to 100000
Sensor 1 / 2 Sensor input current	PV, SV, TV or QV	0 to 100000 nA
Sensor 1 / 2 Polarizing voltage	TV or QV	-1000 to 1000 mV
Sensor 1 / 2 Pressure	TV or QV	0 to 5000 mmHg
		0 to 200 inHg
		0 to 7 bar
		0 to 7000 mbar
		0 to 700 kPa
		0 to 7 atm

Flow / mA Input Device Variables		
Device Variable Name	Assignable to Dynamic Variables	Variable Range
Sensor 1 / 2 Measurement Type		
Flow Rate (23)	PV, SV, TV or QV	0 to 100000 gal/min
		0 to 100000 gal/hr
		0 to 100000 cu.ft/min
		0 to 100000 cu.ft/hr
		0 to 100000 liter/min
		0 to 100000 liter/hr
		0 to 100000 m3/hr

Flow / mA Input Device Variables (continued)		
Device Variable Name	Assignable to Dynamic Variables	Variable Range
Sensor 1 / 2 Measurement Type		
Scaled mA Input (24)	PV, SV, TV or QV	As per Configuration
	Input Type:	Units:
	Temperature	°C, °F
	Pressure	mmHg, inHg, bar, mbar, kPa, atm
	Flow	gal/min, gal/hr, cu.ft/hr, cu.ft/min, liter/hr, m3/hr
	Other	ft/sec, m/sec, None
	pH/ORP	pH, mV
	Conductivity	µS/cm, mS/cm
	Resistivity	M -cm, K -cm
	Concentration	%, parts per thousand, ppm, ppb
	Weight per Volume	mg/L, µg/L, g/L
Turbidity	FNU, FTU, NTU	
Measurement Parameters		
Sensor 1 / 2 Frequency	TV or QV	0 to 1000 Hz
Sensor 1 / 2 Velocity	PV, SV, TV or QV	0 to 10 ft/sec
		0 to 10 m/sec
Sensor 1 / 2 Totalizer	PV, SV, TV or QV	0 to 1000000 gal
		0 to 1000000 liter
		0 to 1000000 m3
		0 to 1000000 cu.ft
Sensor 1 / 2 mA input	TV or QV	3.6 to 22 mA
Dual Flow Measurements		
Flow ratio	PV, SV, TV or QV	0 to 1000 NA
% Flow ratio	PV, SV, TV or QV	0 to 100 %
% Recovery	PV, SV, TV or QV	0 to 100 % Recovery
Flow difference	PV, SV, TV or QV	-10000 to 10000 gal/min
		-10000 to 10000 gal/hr
		-10000 to 10000 cu.ft/min
		-10000 to 10000 cu.ft/hr
		-10000 to 10000 liter/min
		-10000 to 10000 liter/hr
		-10000 to 10000 m3/hr
Flow total difference	PV, SV, TV or QV	-100000 to 100000 gal
		-100000 to 100000 liter
		-100000 to 100000 m3
		-100000 to 100000 cu.ft

Appendix 2: HART Status Bits

Common Transmitter Status Bits				
Byte	Bit	Message	Severity	Device Status Bits Set
2	2	Sensor 1 Hardware Error	Error	Device Status: bit 7, 3
2	6	Sensor 1 User Data Error	Error	Device Status: bit 7, 3
2	7	Sensor 1 EEPROM Write Error	Error	Device Status: bit 7, 3
3	0	Sensor 1 Sensor Board Unknown	Error	Device Status: bit 7, 3
3	1	Sensor 1 Hardware/Software Mismatch	Error	Device Status: bit 7, 3
3	2	Sensor 1 Sensor Incompatible	Error	Device Status: bit 7, 3
3	3	Sensor 1 Sensor Not Detected	Error	Device Status: bit 7, 3
3	4	Sensor 1 Sensor not communicating	Error	Device Status: bit 7, 3
3	5	Sensor 1 CPU Error	Error	Device Status: bit 7, 3
3	6	Sensor 1 Factory Data Error	Error	Device Status: bit 7, 3
3	7	Sensor 1 ADC Error	Error	Device Status: bit 7, 3
5	2	Sensor 2 Hardware Error	Error	Device Status: bit 7, 3
5	6	Sensor 2 User Data Error	Error	Device Status: bit 7, 3
5	7	Sensor 2 EEPROM Write Error	Error	Device Status: bit 7, 3
6	0	Sensor 2 Sensor Board Unknown	Error	Device Status: bit 7, 3
6	1	Sensor 2 Hardware/Software Mismatch	Error	Device Status: bit 7, 3
6	2	Sensor 2 Sensor Incompatible	Error	Device Status: bit 7, 3
6	3	Sensor 2 Sensor Not Detected	Error	Device Status: bit 7, 3
6	4	Sensor 2 Sensor not communicating	Error	Device Status: bit 7, 3
6	5	Sensor 2 CPU Error	Error	Device Status: bit 7, 3
6	6	Sensor 2 Factory Data Error	Error	Device Status: bit 7, 3
6	7	Sensor 2 ADC Error	Error	Device Status: bit 7, 3
7	0	Maintenance required	Warning	Extended Device bit 0
7	1	Device variable alert	Warning	Extended Device bit 1
9	0	Simulation active	Mode	
9	1	Non-volatile memory defect	Error	
9	2	Volatile memory defect	Error	
9	3	Watchdog reset executed	--	
9	4	Voltage condition out of range	--	
9	5	Environmental condition out of range	--	
9	6	Electric defect	Error	
11	0	Analog channel-2 saturated	Warning	
11	1	Analog channel-3 saturated	Warning	
11	2	Analog channel-4 saturated	Warning	

Common Transmitter Status Bits (continued)				
Byte	Bit	Message	Severity	Device Status Bits Set
14	0	Analog channel-2 fixed	Mode	
14	1	Analog channel-3 fixed	Mode	
14	2	Analog channel-4 fixed	Mode	
21	0	Main board CPU Error	Error	Device Status: bit 7, 3
21	1	User Data Error	Error	Device Status: bit 7, 3
21	2	Factory Data Error	Error	Device Status: bit 7, 3
22	1	Unknown power supply	Warning	Device Status: bit 4
22	2	Unknown line frequency	Warning	Device Status: bit 4
22	3	Factory calibration error	Warning	Device Status: bit 4
22	4	Keypad error	Warning	Device Status: bit 4
22	5	Overheating LCD	Warning	Device Status: bit 4
22	6	Excess output current	Warning	Device Status: bit 4
23	0	Relay-1 Energized	Mode	
23	1	Relay-2 Energized	Mode	
23	2	Relay-3 Energized	Mode	
23	3	Relay-4 Energized	Mode	
24	0	Sensor 1 Zeroing in Progress	Mode	Device Status: bit 4
24	1	Sensor 1 Calibration in Progress	Mode	Device Status: bit 4
24	2	Sensor 1 Standardization in Progress	Mode	Device Status: bit 4
24	3	Sensor 1 Stabilization in Progress	Mode	Device Status: bit 4
25	0	Sensor 2 Zeroing in Progress	Mode	Device Status: bit 4
25	1	Sensor 2 Calibration in Progress	Mode	Device Status: bit 4
25	2	Sensor 2 Standardization in Progress	Mode	Device Status: bit 4
25	3	Sensor 2 Stabilization in Progress	Mode	Device Status: bit 4

Temperature Status Bits				
Byte	Bit	Message	Severity	Device Status Bits Set
2	0	Sensor 1 RTD Open	Error	Device Status: bit 7, 3
2	1	Sensor 1 RTD Out Of Range	Error	Device Status: bit 7, 3
5	0	Sensor 2 RTD Open	Error	Device Status: bit 7, 3
5	1	Sensor 2 RTD Out Of Range	Error	Device Status: bit 7, 3
17	1	Sensor 1 Temperature High	Warning	Device Status: bit 4
17	2	Sensor 1 Temperature Low	Warning	Device Status: bit 4
17	3	Sensor 1 RTD Sense Line Open	Warning	Device Status: bit 4
20	1	Sensor 2 Temperature High	Warning	Device Status: bit 4
20	2	Sensor 2 Temperature Low	Warning	Device Status: bit 4
20	3	Sensor 2 RTD Sense Line Open	Warning	Device Status: bit 4

pH Board Status Bits				
Byte	Bit	Message	Severity	Device Status Bits Set
2	3	Sensor 1 Reference Impedance Too High	Error	Device Status: bit 7, 3
2	4	Sensor 1 Glass Impedance Too High	Error	Device Status: bit 7, 3
2	5	Sensor 1 Broken Glass	Error	Device Status: bit 7, 3
5	3	Sensor 2 Reference Impedance Too High	Error	Device Status: bit 7, 3
5	4	Sensor 2 Glass Impedance Too High	Error	Device Status: bit 7, 3
5	5	Sensor 2 Broken Glass	Error	Device Status: bit 7, 3
16	3	Sensor 1 Broken Glass Disabled	Warning	Device Status: bit 4
17	7	Sensor 1 No Solution Ground	Warning	Device Status: bit 4
19	3	Sensor 2 Broken Glass Disabled	Warning	Device Status: bit 4
20	7	Sensor 2 No Solution Ground	Warning	Device Status: bit 4
24	6	Sensor 1 Offset Error	Mode	Device Status: bit 4
24				Extended Device Status: bit 0
24	7	Sensor 1 Slope Error	Mode	Device Status: bit 4
24				Extended Device Status: bit 0
25	6	Sensor 2 Offset Error	Mode	Device Status: bit 4 Extended Device Status: bit 0
25	7	Sensor 2 Slope Error	Mode	Device Status: bit 4 Extended Device Status: bit 0

Contacting and Toroidal Conductivity Status Bits				
Byte	Bit	Message	Severity	Device Status Bits Set
16	0	Sensor 1 Conductivity Negative Reading	Warning	Device Status: bit 4
	1	Sensor 1 Percent Out Of range	Warning	Device Status: bit 4
17	5	Sensor 1 Conductivity Board Out Of Range	Warning	Device Status: bit 4
19	0	Sensor 2 Conductivity Negative Reading	Warning	Device Status: bit 4
	1	Sensor 2 Percent Out Of range	Warning	Device Status: bit 4
20	5	Sensor 2 Conductivity Board Out Of Range	Warning	Device Status: bit 4
24	5	Sensor 1 Zero Error	Mode	Device Status: bit 4 Extended Device Status: bit 0
25	5	Sensor 2 Zero Error	Mode	Device Status: bit 4 Extended Device Status: bit 0

Amperometric Status Bits				
Byte	Bit	Message	Severity	Device Status Bits Set
16	2	Sensor 1 Pressure Broken	Warning	Device Status: bit 4
17	6	Sensor 1 Amperometric Board Negative Reading	Warning	Device Status: bit 4
19	2	Sensor 2 Pressure Broken	Warning	Device Status: bit 4
20	6	Sensor 2 Amperometric Board Negative Reading	Warning	Device Status: bit 4

Flow / mA Input Status Bits				
Byte	Bit	Message	Severity	Device Status Bits Set
15	0	Sensor 1 Low Current	Warning	Device Status: bit 4
16	5	Sensor 1 No Flow Detected	Warning	Device Status: bit 4
16	6	Sensor 1 Negative Current	Warning	Device Status: bit 4
16	7	Sensor 1 Excessive Current	Warning	Device Status: bit 4
18	0	Sensor 2 Low Current	Warning	Device Status: bit 4
19	5	Sensor 2 No Flow Detected	Warning	Device Status: bit 4
19	6	Sensor 2 Negative Current	Warning	Device Status: bit 4
19	7	Sensor 2 Excessive Current	Warning	Device Status: bit 4

Turbidity Input Status Bits				
Byte	Bit	Message	Severity	Device Status Bits Set
1	0	Sensor 1 Lamp/LED Failed	Error	Device Status: bit 7, 3
1	1	Sensor 1 Disconnected	Error	Device Status: bit 7, 3
4	0	Sensor 2 Lamp/LED Failed	Error	Device Status: bit 7, 3
4	1	Sensor 2 Disconnected	Error	Device Status: bit 7, 3
15	1	Sensor 1 Need Calibration	Warning	Device Status: bit 4
18	1	Sensor 2 Need Calibration	Warning	Device Status: bit 4
21	3	Wrong Power Supply	Error	Device Status: bit 7, 3

[Emerson.com/Rosemount](https://www.emerson.com/Rosemount)



[Youtube.com/user/Rosemount](https://www.youtube.com/user/Rosemount)



[Twitter.com/Rosemount_News](https://twitter.com/Rosemount_News)



[Linkedin.com/company/Emerson-Automation-Solutions](https://www.linkedin.com/company/Emerson-Automation-Solutions)



[facebook.com/Rosemount](https://www.facebook.com/Rosemount)

Emerson

8200 Market Blvd.
Chanhassen, MN 55317,
USA
Tel +1 800 999 9307
Fax +1 952 949 7001
RMTNA.RCCPO@Emerson.com

©2020 Emerson. All rights reserved.

The Emerson logo is a trademark and service mark of Emerson Electric Co. Rosemount is a mark of one of the Emerson family of companies. All other marks are the property of their respective owners.

The contents of this publication are presented for information purposes only, and while effort has been made to ensure their accuracy, they are not to be construed as warranties or guarantees, express or implied, regarding the products or services described herein or their use or applicability. All sales are governed by our terms and conditions, which are available on request. We reserve the right to modify or improve the designs or specifications of our products at any time without notice.

ROSEMOUNT™

